



Fence & Railing

We have an extensive stock of extrusions for the fabrication of Mechanical & Welded Railing as well as Glass & Cable Railing. We also carry railing channel, pipe brackets, square tube for pickets and an assortment of Castings to finish off any railing project.

- Mechanical Fence & Railing pages 01-03
- Welded Railing pages 04-06
- Dixie Cap Railing pages 07
- Railing Channel page 08
- Pipe & Wall Brackets page 09
- Glass Railing pages 10-17
- Glass Base Shoe page 18
- Cable Railing pages 19-20
- Castings Castings 01-04

Proud Members:



Mechanical Fence & Railing

<p>Top Cap - HR-1 HR-1-WH White x 20' HR-1-BR Bronze x 20' HR-1-BR (MO) MO Bronze x 20' HR-1-MF (MO) Mill Finish x 20' HR-1-TB (MO) Textured Black x 20' 52-63-5578 Black x 25' <i>mates with HR-2, HR-2C; 8 pc sub-bundles</i></p> <div style="text-align: center;"> </div> <p>Accepts Castings: End Cap #75: 21-00-100 Wall Mount #56: 21-00-187</p>	<p>Top Cap - HR-8 HR-8-WH White x 20' HR-8-BR Bronze x 20' <i>mates with HR-2, HR-2C; 4 pc sub-bundles</i></p> <div style="text-align: center;"> </div> <p>Accepts Castings: End Cap #96: 21-00-131 Wall Mount #63: 21-00-063</p>	<p>Top Cap - HR-10 HR-10-WH White x 20' HR-10-BR Bronze x 20' HR-10-BK Black x 20' <i>mates with HR-11A; 6 pc sub-bundles</i></p> <div style="text-align: center;"> </div> <p>Accepts Castings: End Cap #34: 21-00-105 Flat End Cap #34F: 52-00-147 Wall Mount #13: 21-00-186</p>
<p>Top Cap - HR-14 HR-14-WH White x 20' HR-14-BR Bronze x 20' HR-14-BK Black x 20' <i>mates with HR-2, HR-2C; 8 pc sub-bundles</i></p> <div style="text-align: center;"> </div> <p>Accepts Castings: End Cap #188: 21-00-114 Wall Mount #62: 21-00-155</p>	<p>Top Cap - HR-17 MILL ORDER HR-17-WH <i>mates with HR-2, HR-2C; 6 pc sub-bundles</i></p> <div style="text-align: center;"> </div>	



Bottom Channel - HR-3
HR-3-WH White x 19' 6"
HR-3-BR Bronze x 19' 6"
HR-3-BR (MO) MO Bronze x 19' 6"
HR-3-BK Black x 19' 6"
HR-3-TB (MO) Textured Black x 19' 6"
HR-3-MF (MO) Mill Finish x 19' 6"
All mate with HR-2; 8 pc sub-bundles

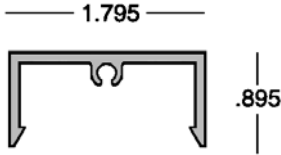

Accepts Casting:

Wall Mount #54: 21-00-316

Snap Channel - HR-12
HR-12-WH White x 19' 6"
HR-12-BR Bronze x 19' 6"
HR-12-BK Black x 19' 6"
12 pc sub-bundles

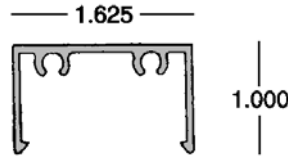

Accepts Casting:

Wall Mount #39: 21-00-185

Bottom Channel - HR-12A x 19' 6"
HR-12A-BR Bronze - **CLOSEOUT**
12 pc sub-bundles
White available as a SPECIAL ORDER

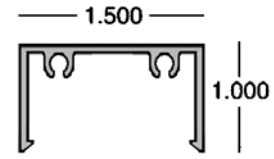

Accepts Casting:

Wall Mount #68: 21-00-183

Bottom Channel - HR-12B
HR-12B-WH White x 19' 6"
HR-12B-BR Bronze x 19' 6"
HR-12B-BK Black x 19' 6"
12 pc sub-bundles

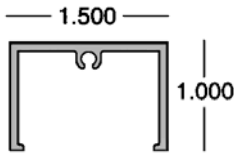

Accepts Casting:

Wall Mount #68: 21-00-183

Snap Plate HR-2
52-63-6147 White x 19' 6" (FL)
52-63-6149 Bronze x 19' 6" (FL)
HR-2-MF (MO) Mill Finish x 20'
HR-2-WH White x 21' 1"
HR-2-BR Bronze x 21' 1"
HR-2-BR (MO) MO Bronze x 21' 1"
HR-2-BK Black x 21' 1"
HR-2-TB (MO) Textured Black x 21' 1"
HR-2-WH-2 White x 23'
HR-2-BR-2 Bronze x 23'
HR-2-BK-2 Black x 23'
All mate with HR-1, 3, 4, 4A, 4C, 6, 7, 8, 14
12 pc sub-bundles

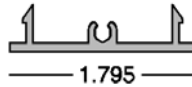

Snap Plate - HR-2C - CLOSEOUT
HR-2C-WH White x 20'
HR-2C-BK Black x 20'
All mate with HR-1, HR-3, HR-8, HR-14, HR-17; All use Pickets HR-5 and HR-13
10 pc sub-bundles

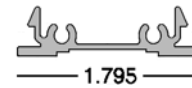

Snap Plate - HR-11A
HR-11A-WH White x 20'
HR-11A-BR Bronze x 20'
HR-11A-BK Black x 20'
All mate with HR-10; All use Pickets HR-5 and HR-13; 12 pc sub-bundles

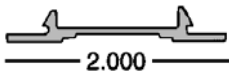

Snap Plate - HR-15
HR-15-WH-1 White x 18' 6"
mates with HR-16; 16 pc sub-bundles

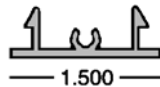

Snap Post - HR-4
52-63-6146 White x 19' 6"
52-63-6148 Bronze x 19' 6"
HR-4-WH White x 21' 1"
HR-4-BR Bronze x 21' 1"
HR-4-BK Black x 21' 1"
HR-4-WH-2 White x 23'
HR-4-BR-2 Bronze x 23'
HR-4-BK-2 Black x 23'
mates with HR-2
6 pc sub-bundles

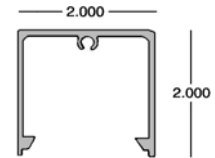

Accepts Casting:

Floor Flange #40: 21-00-210

Snap Post - HR-4A
HR-4A-WH White x 21' 1"
HR-4A-BR Bronze x 21' 1"
HR-4A-BR (MO) MO Bronze x 21' 1"
HR-4A-TB (MO) Textured Black x 21' 1"
HR-4A-BK Black x 25'
mates with HR-2; 6 pc sub-bundles

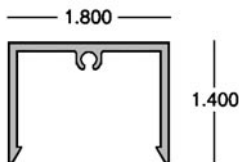

Accepts Casting:

Floor Flange #50: 21-00-195

Floor Flange #50HD 21-00-196

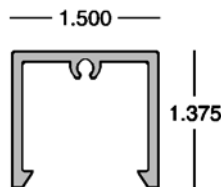

Snap Post - HR-16
HR-16-WH-1 White x 18' 6"
mates with HR-15; 8 pc sub-bundles



Accepts Casting:

Floor Flange #42: 21-00-309

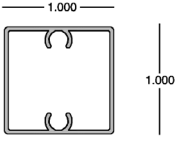
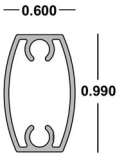
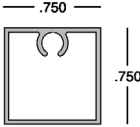
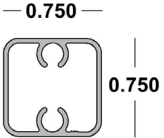

<p>1" Picket - HR-5 200-WH-075 White x 19' 10" 200-MB-075 Bronze x 19' 10" HR-5-WH White x 23' HR-5-BR Bronze x 23' HR-5-BK Black x 23' 6" HR-5-TB (MO) Textured Black x 23' HR-5-MF (TX) Mill Finish x 23' 20 pc sub-bundles</p> 	<p>1" Oval Picket MILL ORDER - 52-63-12344</p> 	<p>3/4" Picket - HR-13 HR-13-WH-1 White x 19' 1" HR-13-BR-1 Bronze x 19' 1" HR-13-BK Black x 19' 1" HR-13-WH White x 22' 5" HR-13-BR Bronze x 22' 5" 20 pc sub-bundles</p> 	<p>3/4" Picket w/radius HR-13R (.120 Radius) HR-13R-WH20 White x 20' HR-13R-BR20 Bronze x 20' HR-13R-WH (MO) White x 24' HR-13R-BR (MO) Bronze x 24' HR-13R-TB (MO) Text Black x 24' 20 pc sub-bundles</p> 	<p>3/4" Spears 19-63-105PS1 .062 x 58" 19-63-105PS2 .062 x 70"</p> <p>1" Spears 19-63-130PS1 .060 x 58" 19-63-130PS2 .060 x 70"</p> 
---	---	--	--	---

Aluminum Posts & Pickets

Painted Square Tube - 6063-T6

Stock Code	Size in Inches	Approx. Wt/Lin ft.
19-WH-204	2 x .093 x 24' White	0.851
19-MB-204	2 x .093 x 24' Bronze	0.851
19-BK-204	2 x .093 x 24' Black	0.851
19-IV-300	2 x .125 x 24' Ivory	1.125
19-WH-305	2 x .125 x 24' 6" White	1.125
19-MB-305	2 x .125 x 24' 6" Bronze	1.125
19-BG-305	2 x .125 x 24' 6" Beige	1.125
19-COLOR-212	2 x .250 x 24' **	2.100
19-WH-003	3 x .093 x 24' White	1.298
19-MB-003	3 x .093 x 24' Bronze	1.298
19-63-231TB (MO)	3 x .093 x 24' Textured Black	1.298
200-WH-027	3 x .093 x 30' White	1.298
200-MB-027	3 x .093 x 30' Bronze	1.298
19-WH-225	3 x .125 x 20' White	1.726
19-WH-220	3 x .125 x 24' White	1.726
19-MB-235	3 x .125 x 24' Bronze	1.726
19-IV-235	3 x .125 x 24' Ivory	1.726
19-BG-235	3 x .125 x 24' Beige	1.726
19-BK-235	3 x .125 x 24' Black	1.726
19-COLOR-240	3 x .250 x 24' **	3.300
52-COLOR-4424	3.50 x .125 x 24' **	2.024
19-WH-245	4 x .125 x 20' White	2.325
19-WH-400	4 x .125 x 24' White	2.325
19-MB-246	4 x .125 x 24' Bronze	2.325
19-IV-400	4 x .125 x 24' Ivory	2.325
19-BG-400	4 x .125 x 24' Beige	2.325
19-BK-400	4 x .125 x 24' Black	2.325
200-WH-028	4 x .125 x 30' White	2.325
200-MB-028	4 x .125 x 30' Bronze	2.325
19-WH-2500	4 x .250 x 20' White	4.500
19-MB-2500	4 x .250 x 24' Bronze	4.500
19-IV-2500	4 x .250 x 24' Ivory	4.500
19-BG-2500	4 x .250 x 24' Beige	4.500
19-WH-2501	4 x .250 x 24' 6" White	4.500
3" Scalloped Square Tube		
42-WH-003 (MO)	3" x 20' White	0.757
200-WH-017	3" x 24' White	0.757
200-MB-017	3" x 24' Bronze	0.757
200-WH-018	3" x 30' White	0.757
200-MB-018	3" x 30' Bronze	0.757

**COLOR - Available in White (WH), Bronze (MB), Ivory (IV), and Beige (BG)

Aluminum Woven Wire Mesh - **NEW!**

Alloy 1350 - H16

ID Size	Stock Code	Size in Inches	Approx. Wt/Sheet
2.00 ID	50-2X2WM-4896	.236 x 48 x 96	17.60
2.00 ID	50-2X2WM-48120	.236 x 48 x 120	21.78
1.75" ID; 2.25" OD		Alloy 1350 - H16 - CLOSEOUT!	
50-WWM-4896 (MO)		.236 x 48 x 96	20.60

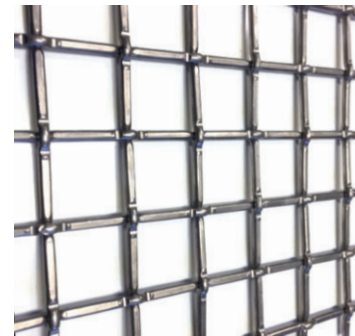

Woven Wire Mesh Framing Options

see *Stiffeners, Enclosures & Gates 11* for schematic

13-63-205	1/2 x 3/4 x 1/8 Channel x 20' (6063-T52)
60-00-205	MP-1A (1 x 1 x 24')
59-63-002 (TX)	MP-1A (1 x 1 x 24')

Hard-Rok 5 Gallon Bucket
61-00-007 *Anchoring Cement*
Contains no gypsum or chlorides;
Quick setting anchoring cement;



Quik Rok 5 Gallon Bucket
61-00-001 *Anchoring Cement*
NEVER to be used to anchor balcony railing or any similar human life safety structures



45° Post x 20' #2
52-63-2033 wt/ft: 1.041
Wall: .085/.150 6061-T6

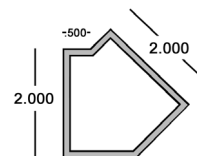

16 oz Touch Up Spray Paint

Stock Code	Color
35-00-100	White
35-00-100G	White Gloss
35-00-105	Bronze
35-00-105G	Bronze Gloss
35-00-110	Ivory Gloss
35-00-115 (TX)	Beige
35-00-115G	Beige Gloss
35-00-120	Black
35-00-120G	Black Gloss

Mechanical Railing - HR-1 Schematic

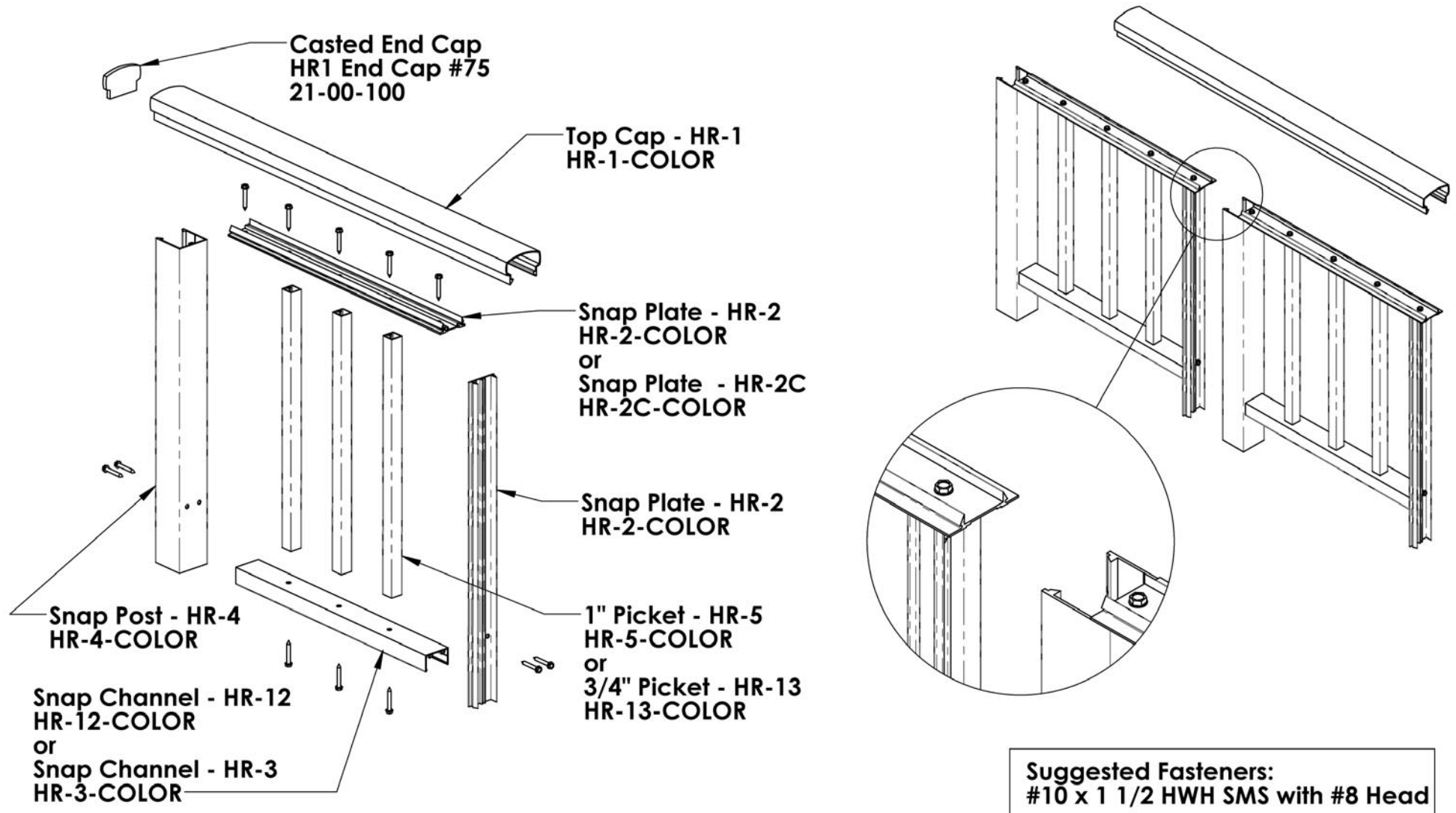

ADDITIONAL MECHANICAL RAILING EXTRUSIONS AND CASTINGS ALSO AVAILABLE

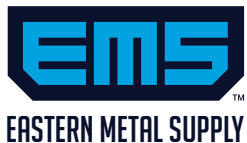

www.easternmetal.com • info@easternmetal.com v 11/23

FL: 800-432-2204 • NC/DE/GA: 800-343-8154 • TX/LA: 800-996-6061 • MO/OH/IN: 888-822-6061

Mechanical Railing - HR-10 Schematic

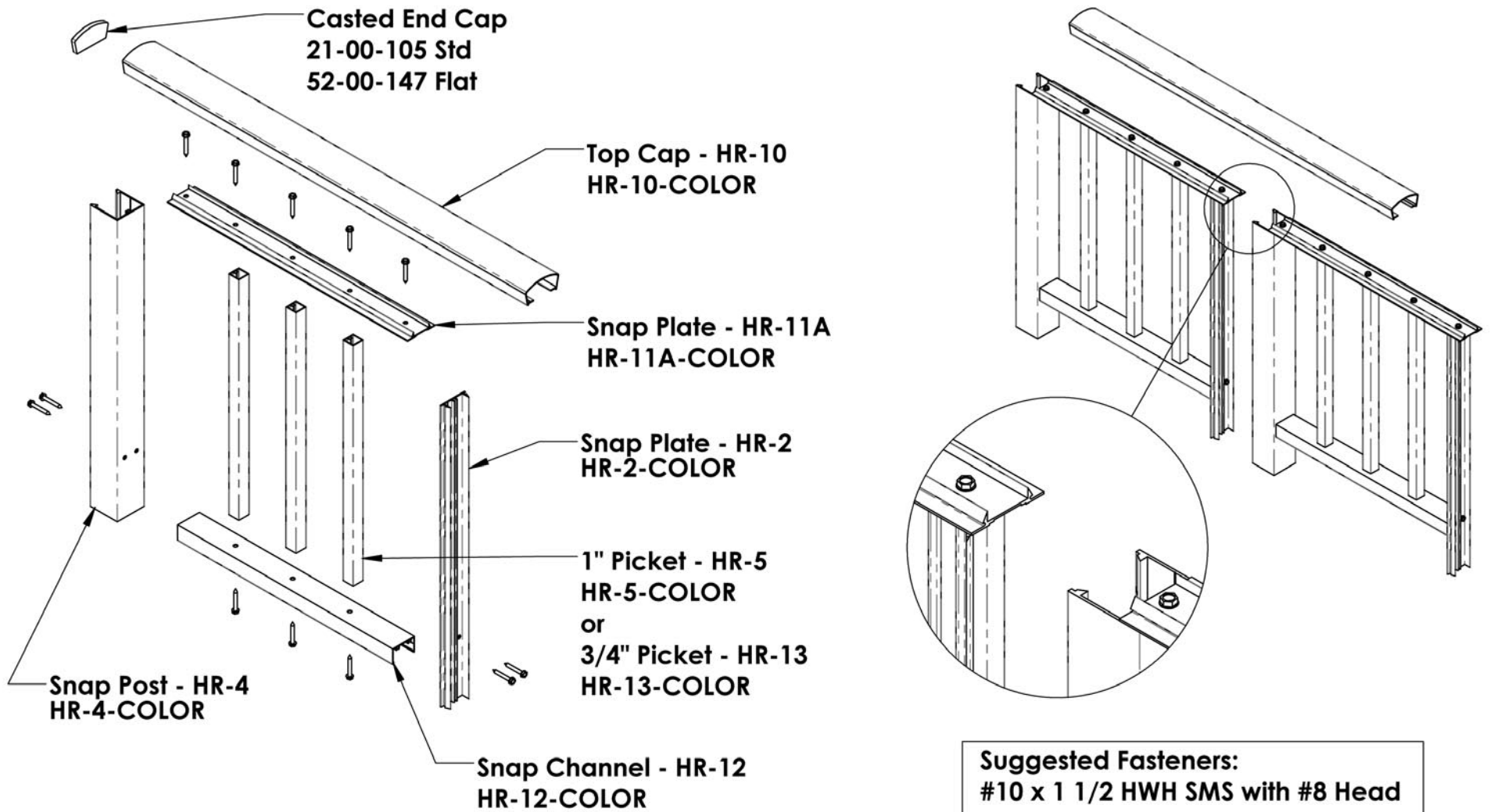

ADDITIONAL MECHANICAL RAILING EXTRUSIONS AND CASTINGS ALSO AVAILABLE

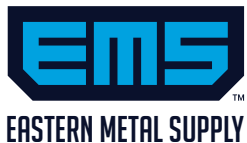

www.easternmetal.com • info@easternmetal.com v 11/23

FL: 800-432-2204 • NC/DE/GA: 800-343-8154 • TX/LA: 800-996-6061 • MO/OH/IN: 888-822-6061

Mechanical Railing - HR-14 Schematic

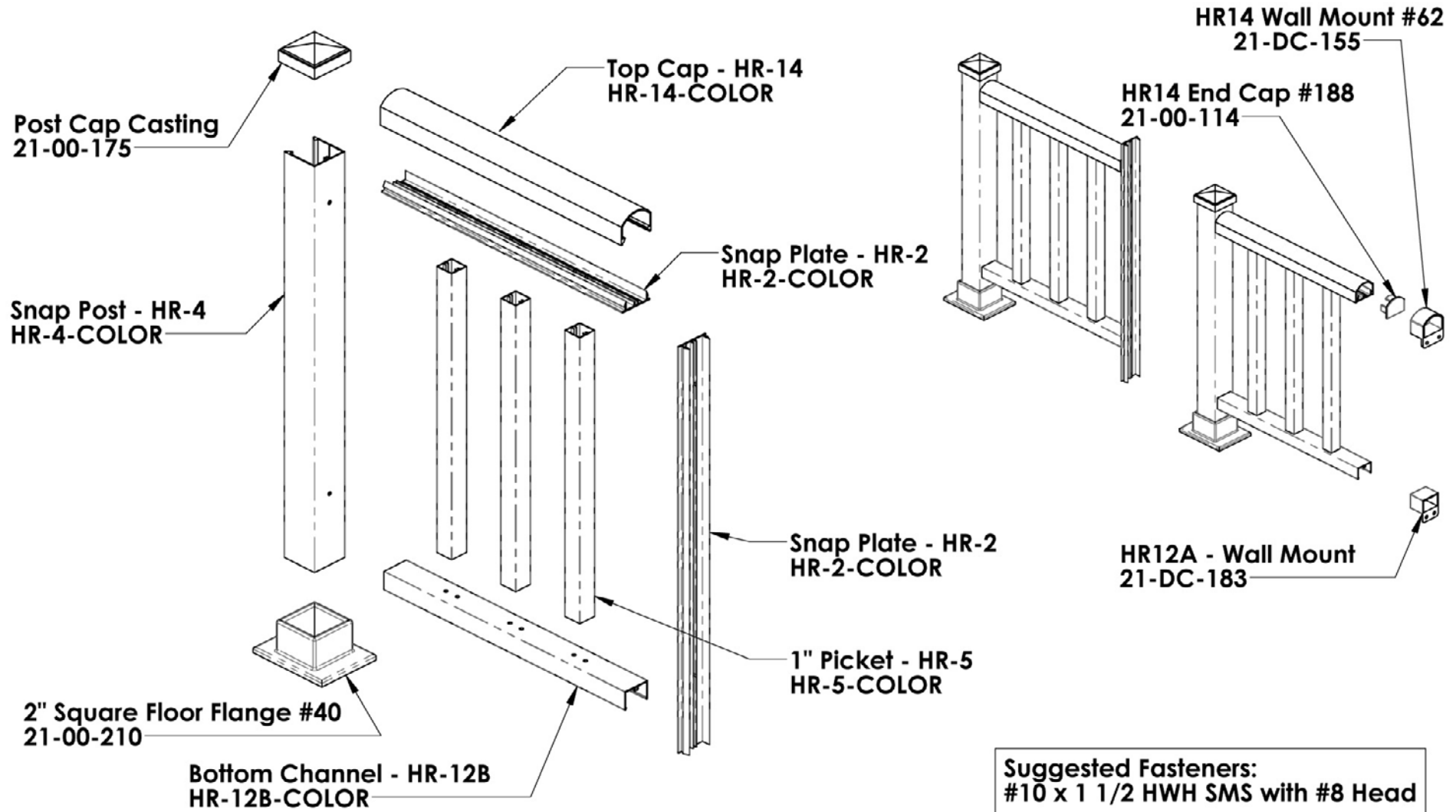

ADDITIONAL MECHANICAL RAILING EXTRUSIONS AND CASTINGS ALSO AVAILABLE

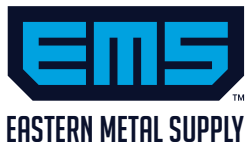

www.easternmetal.com • info@easternmetal.com v 11/23

FL: 800-432-2204 • NC/DE/GA: 800-343-8154 • TX/LA: 800-996-6061 • MO/OH/IN: 888-822-6061

Mechanical Railing - Post to Post Schematic

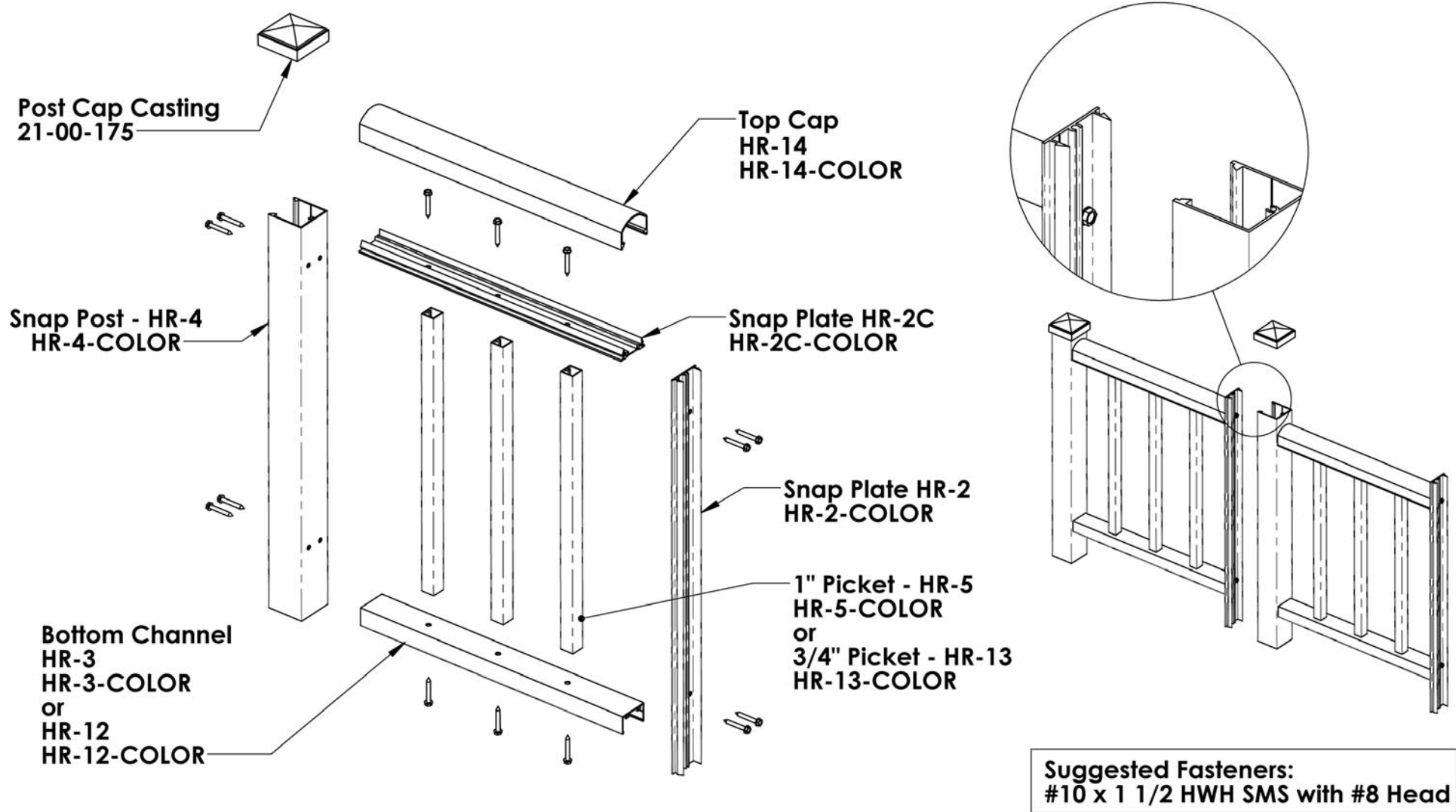

ADDITIONAL MECHANICAL RAILING EXTRUSIONS AND CASTINGS ALSO AVAILABLE

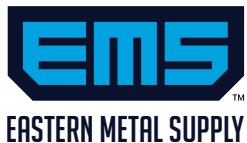

www.easternmetal.com • info@easternmetal.com v 11/23

FL: 800-432-2204 • NC/DE/GA: 800-343-8154 • TX/LA: 800-996-6061 • MO/OH/IN: 888-822-6061

Mechanical Railing - Midrail Schematic

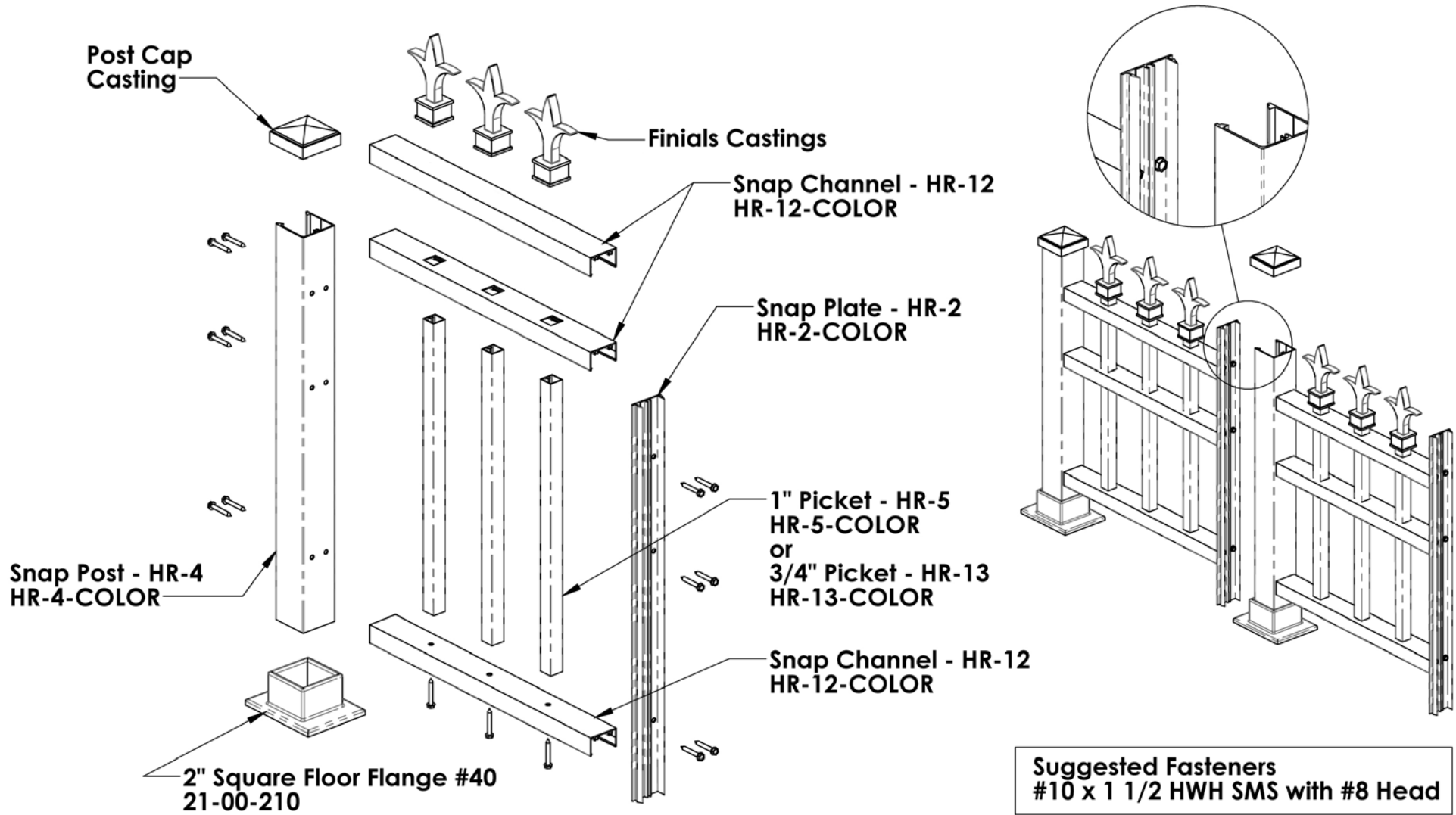

ADDITIONAL MECHANICAL RAILING EXTRUSIONS AND CASTINGS ALSO AVAILABLE

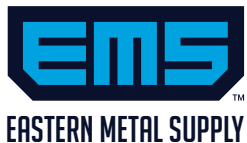

www.easternmetal.com • info@easternmetal.com v 11/23

FL: 800-432-2204 • NC/DE/GA: 800-343-8154 • TX/LA: 800-996-6061 • MO/OH/IN: 888-822-6061



<p>1 x 2 Open Back Mates with 1 x 2 Patio Snap 200-WH-001 White x 24' 200-MB-001 Bronze x 24' 200-WH-002 White x 30' 200-MB-002 Bronze x 30'</p>	<p>1 x 2 Patio Snap Mates with 1 x 2 Open Back 200-WH-116 White x 24' 200-MB-116 Bronze x 24'</p>	<p>1 x 3 Open Back 200-WH-070 White x 24' 200-MB-070 Bronze x 24' 200-WH-071 White x 30' 200-MB-071 Bronze x 30'</p>	<p>1 x 2 Self-Mating Snap 200-WH-101 White x 24' 200-MB-101 Bronze x 24' 200-WH-005 White x 25' 200-MB-005 Bronze x 25'</p>	<p>1 x 3 Self-Mating Snap with Screw Bosses 200-WH-206 White x 25' 200-MB-206 Bronze x 25'</p>	<p>1 x 3 Self-Mating Snap 200-WH-006 White x 25' 200-MB-006 Bronze x 25' 200-WH-129 White x 30' 200-MB-129 Bronze x 30'</p>
<p>1 x 4 Self-Mating Snap 200-WH-007 White x 24' 200-MB-007 Bronze x 24' 200-WH-008 White x 30' 200-MB-008 Bronze x 30'</p>	<p>2" x 4" Self Mating Beam 200-WH-040 White x 18' 200-MB-040 Bronze x 18' 200-WH-041 White x 20' 200-MB-041 Bronze x 20' 200-WH-077 White x 24' 200-MB-077 Bronze x 24' 200-WH-042 White x 30' 200-MB-042 Bronze x 30'</p>	<p>2" x 5" Self Mating Beam 200-COLOR-043 x 18"* 200-COLOR-044 x 20' 200-COLOR-074 x 22' 200-MB-041 x 24' 200-COLOR-046 x 26' 200-COLOR-117 x 28' 200-COLOR-118 x 30' <small>*COLOR = White (WH) & Bronze (MB)</small></p>	<p>3/4" Picket x 19' 1" HR-13-WH-1 White HR-13-BR-1 Bronze HR-13-BK Black</p> <p>3/4" Picket x 22' 5" HR-13-WH White HR-13-BR Bronze</p>	<p>1" Picket x 19' 1" 200-WH-075 White 200-MB-075 Bronze</p> <p>1" Picket x 23' HR-5-WH White HR-5-BR Bronze</p>	
<p>18/14 Charcoal Pool & Patio Enclosure Screen x 100' Rolls 200-CC-025 36" 200-CC-024 60" 200-CC-026 72" 200-CC-027 78" 200-CC-028 84" 200-CC-034 90" 200-CC-029 96" 200-CC-023 102" 200-CC-030 108" Flat Spline x 1000' 200-CC-031</p>	<p>20/20 Charcoal Pool & Patio Enclosure Screen x 100' Rolls (No See Um) NYW-202036 36" NYW-202072 72" NYW-202084 84" NYW-202096 96" NYW-2020108 108"</p>	<p>Flat Spline Roller 200-SR-10</p>	<p>Sheet Metal Screws (Bags of 100) 1015SMSW 10 x 1.5" White 1015SMSB 10 x 1.5" Bronze 102SMSW 10 x 2" White 102SMSB 10 x 2" Bronze 103SMSW 10 x 3" White 103SMSB 10 x 3" Bronze 104SMSW 10 x 4" White 104SMSB 10 x 4" Bronze</p>	<p>Self Drilling Screws (Bags of 100) 1475SDW 1/4 x 3/4" White 1475SDB 1/4 x 3/4" Bronze 141SDW 1/4 x 1" White 141SDB 1/4 x 1" Bronze 142SDW 1/4 x 2" White 142SDB 1/4 x 2" Bronze 143SDW 1/4 x 3" White 143SDB 1/4 x 3" Bronze 875SDW 8 x 3/4" White 875SDB 8 x 3/4" Bronze 8916SDW 8 x 9/16" White 8916SDB 8 x 9/16" Bronze</p>	<p>Self Drilling Screws (con't) (Bags of 100) 1075SDW 10 x 3/4" White 1075SDB 10 x 3/4" Bronze 1275SDW 12 x 3/4" White 1275SDB 12 x 3/4" Bronze 143SDW 14 x 3" White 143SDB 14 x 3" Bronze</p>

BALCONY SCREEN RAIL SYSTEM

1 x 2 Open Back
200-COLOR-001 or 002
or
1 x 3 Open Back
200-COLOR-070 or 071

1 x 3 Self-Mating Snap
200-COLOR-006 or 129 or 206
or
1 x 4 Self-Mating Snap
200-COLOR-007 or 008

1 x 2 Self-Mating Snap
200-COLOR-005 or 101

1" Picket - HR-5
HR-5-COLOR
or
3/4" Picket - HR-13
HR-13-COLOR

1 x 2 Open Back
200-COLOR-001 or 002
or
1 x 3 Open Back
200-COLOR-070 or 071

Note! Suggest using #10 x 2" lg. SMS

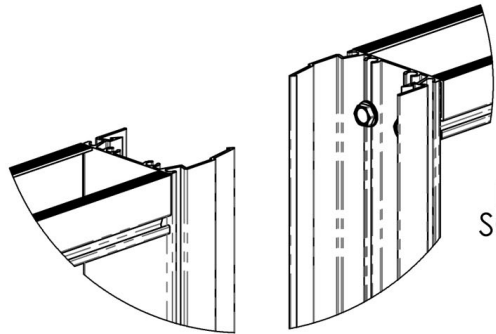

DETAIL A
SCALE 1 : 3

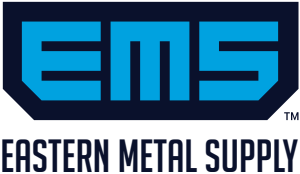
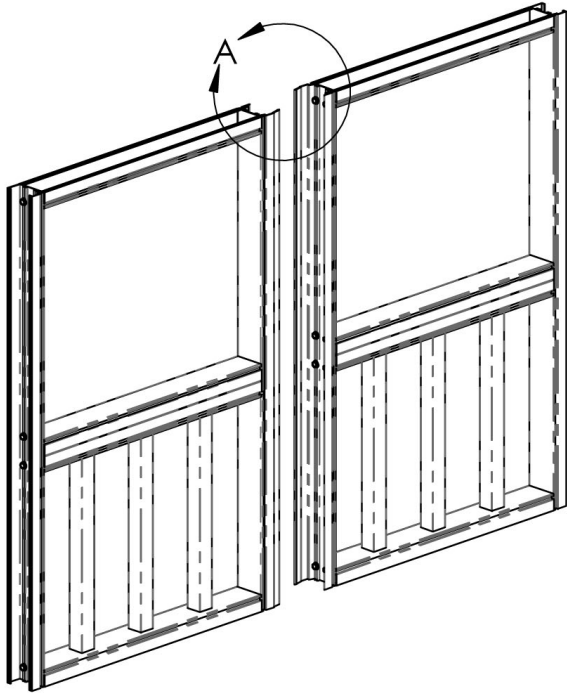



Welded Railing

2-5/8" Hollow Cap x 25' 10" - 129

28-63-210 wt/ft: 0.573

accepts 3/4" Picket with 2" Post; Mates w/#133

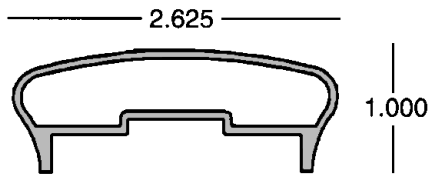

Accepts Castings:

End Cap #28: 21-00-135

Wall Mount #52: 21-00-302

2-5/8" Solid Cap x 25' 10" - 130

28-63-200 wt/ft: 0.530

accepts 3/4" Picket w/2" Post; Mates w/#133

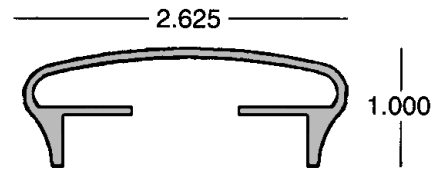

Accepts Castings:

End Cap #28: 21-00-135

Wall Mount #52: 21-00-302

Outside Sleeve x 20' - 133

28-63-220 wt/ft: 0.732

mates with #129 and #130

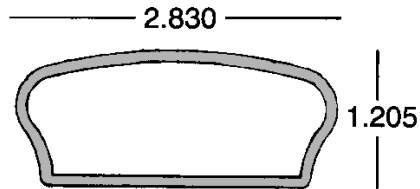

2" x 1" Hollow Cap x 20' - 131

28-63-275 wt/ft: 0.437

accepts 3/4" Picket with 1-1/2" Post

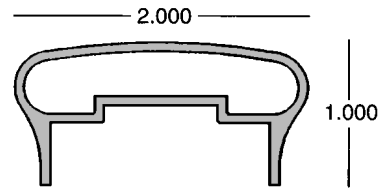

Accepts Castings:

End Cap #261: MILL ORDER - 21-00-330

Wall Mount #329: MILL ORDER

3" Oval Top Cap x 25' - 147

28-63-267 wt/ft: 0.635

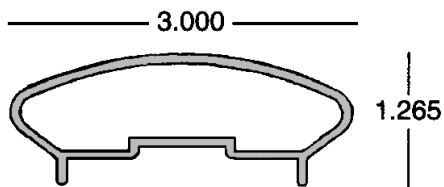

Accepts Castings:

Wall Mount: MILL ORDER: 21-00-19

Outside Sleeve for 3" Oval Top Cap 148

Mill Order **52-63-8767** wt/ft: 0.941

mates with #147

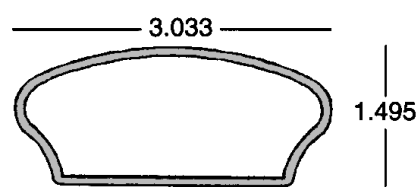

2-5/8" Hollow Cap x 25' 10" 135
28-63-215 wt/ft: 0.670
 accepts 3/4" and 1" Pickets with 2" Post;
 Mates w/ #136 and #137

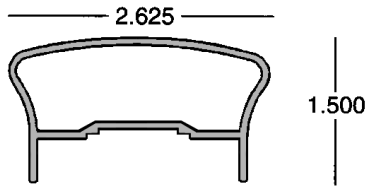

Accepts Castings:
 End Cap #18: 21-00-140, Flat End Cap #18F:
 21-00-140F; 5052 Flat End Cap: 21-5052-140
 Wall Mount #271: 21-00-160

2-5/8" Inner Splice x 10' 136
28-63-208 wt/ft: 0.344
 mates with #135 (28-63-215)

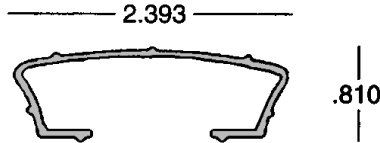

2-5/8" Outside Sleeve x 20' 137
28-63-225 wt/ft: 0.840
 mates with #135 (28-63-215)

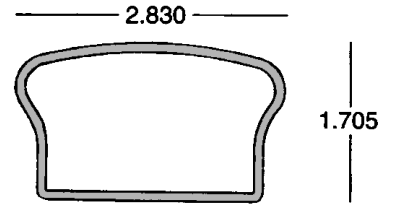

4 x 2 Oval Top Cap x 24' - 152
28-63-285 wt/ft: 1.172
 accepts 3/4" Picket ; accepts 1-1/2"
 and 2" Post

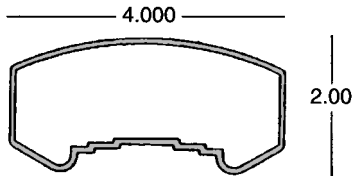

Accepts Castings:
 End Cap #167: MILL ORDER - 21-00-313
 Wall Mount #680: MILL ORDER - 21-00-680

4 x 2 Inner Splice x 12'
52-63-13204 wt/ft: 0.655
 mates with #152 (28-63-285)

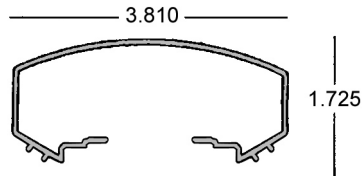

Top Cap x 24' - 139
28-63-255 wt/ft: 1.477
 (less radius)
 accepts 3/4" Picket
 with 2" Post

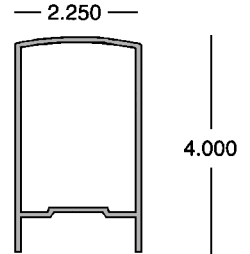

Accepts Castings:
 End Cap #14: 21-00-146
 Wall Mount #24: 21-00-165

Top Cap x 24' - 140
28-63-256 wt/ft: 1.274
 (more radius)
 accepts 3/4" Picket
 with 2" Post

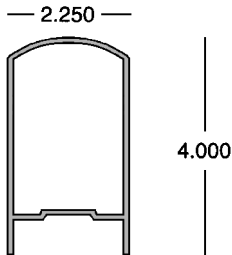

Accepts Castings:
 End Cap #70: 21-00-145
 Wall Mount #190W: 21-00-190W

Top Cap x 24' - 144
MILL ORDER 28-63-260
wt/ft: 1.740
 accepts 3/4" Picket & 2" Post

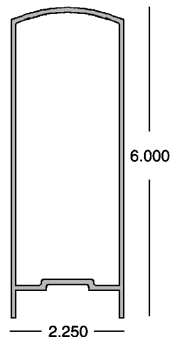

3" Round Top Cap x 24' - 149
28-63-265 wt/ft: 1.001
 accepts 3/4" and 1" Pickets
 & 2" Post; mates with
 #150 and #151

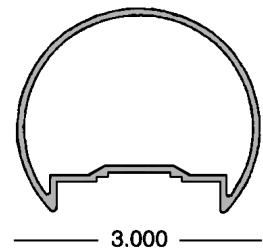

Accepts Castings:
 End Cap #97 21-00-120, 5052 Flat End
 Cap: 21-5052-120
 Wall Mount #185: 21-00-1850

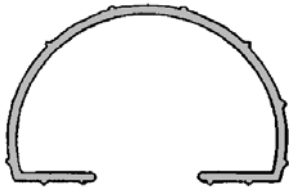
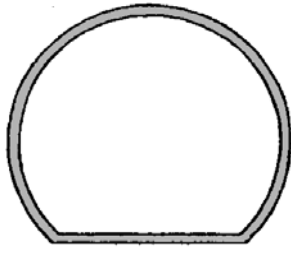
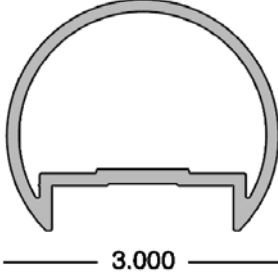
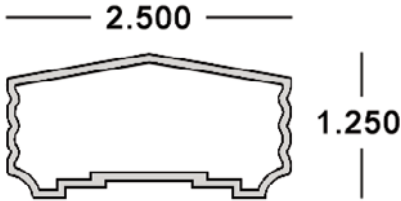
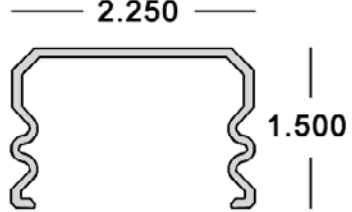
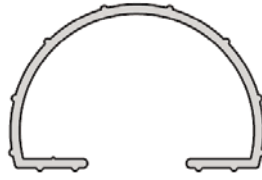
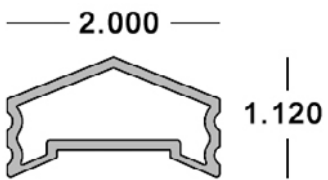
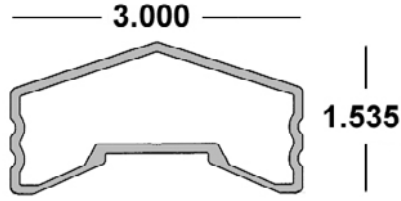
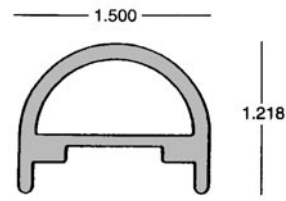

<p>Inside Sleeve x 10' 40-63-701 <i>mates with #149</i></p> <p>150 wt/ft: 0.718</p> 	<p>Outside Sleeve x 10' 28-63-263 <i>mates with #149</i></p> <p>151 wt/ft: 1.042</p> 	<p>3" Round Top Cap - Heavy Wall MILL ORDER - 52-63-12353 wt/ft: 1.489 <i>accepts 3/4" Picket & 2" Post; mates with 52-63-12354</i></p>  <p style="text-align: center;">3.000</p> <p>Accepts Castings: End Cap #97 21-00-120, 5052 Flat End Cap: 21-5052-120 Wall Mount #185: 21-00-1850</p>
<p>2-1/2" Colonial Top Rail x 20' 28-63-063 (DE) wt/ft: 0.600 Wood Style <i>Accepts 3/4" Picket</i></p> 	<p>2-1/4" Colonial Bottom Channel x 20' 28-63-062 (DE) wt/ft: 0.557 Wood Style</p> 	<p>Inside Sleeve for 3" Round Top Cap MILL ORDER 52-63-12354 wt/ft: 0.690 <i>mates with MILL ORDER 52-63-12353</i></p> 
<p>2" x 1.120" Colonial Top Rail x 20' 7849-10 (NC/DE) wt/ft: 0.584 Wood Style <i>Accepts 1" Picket</i></p> 	<p>3" x 1.535" Colonial Top Rail x 20' 28-63-305 (NC) wt/ft: 0.878 Wood Style <i>Accepts 1" Picket</i></p> 	<p>Handicap Grip Rail x 20' - 132 52-63-1641 wt/ft: 0.665 <i>accepts 3/4" Picket with 1-1/4" Post</i></p>  <p style="text-align: center;">1.500</p> <p style="text-align: right;">1.218</p> <p>Accepts Castings: End Cap #294 21-00-294</p>



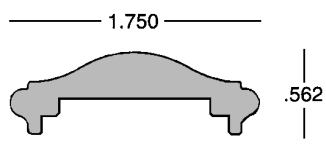
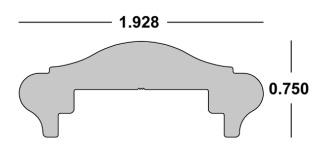
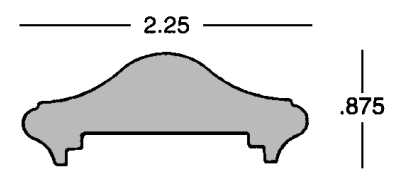
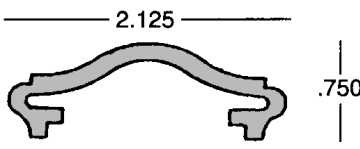
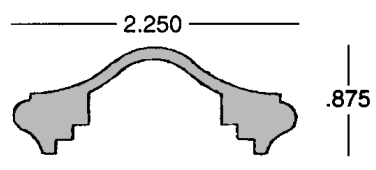
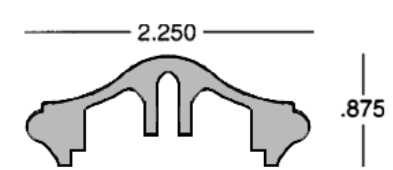
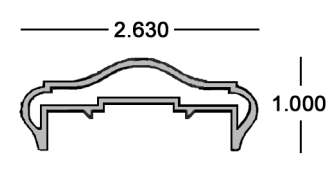
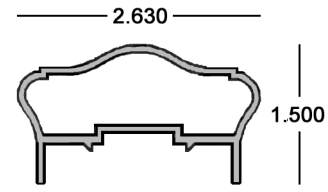
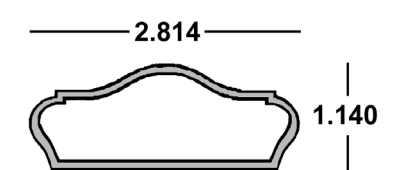
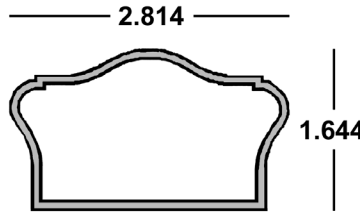

Welded Railing: Dixie Caps

	<p>Dixie Cap x 20' - 154 28-63-100 wt/ft: 0.516 <i>accepts 1" & 1-1/4" Channels</i></p> 	<p>Dixie Cap x 20' 28-63-103 wt/ft: 0.786 <i>accepts 1" & 1-1/4" Channel</i></p> 
<p>Dixie Cap x 20' - 158 28-63-230 wt/ft: 1.180 <i>accepts 1-1/4" & 1-1/2" Channels</i></p> 	<p>Dixie Cap x 20' - 155 28-63-105 wt/ft: 0.413 <i>accepts 1-1/2" Channel</i></p> 	<p>Dixie Cap x 20' - 156 28-63-110 wt/ft: 0.668 <i>accepts 1", 1-1/4" & 1-1/2" Channel</i></p> 
<p>2-1/4" Dixie Cap x 20' 28-63-111 wt/ft: 0.722 <i>with screw boss; accepts 1-1/2" Channel</i></p> 	<p>2-5/8" x 1" Hollow Dixie Cap x 25' 10" 28-63-290 wt/ft: 0.558 <i>accepts 3/4" & 1" Pickets; 2 x 7/16" Channel; 2" Post</i> <i>mates with 28-63-291</i></p>  <p>Accepts Castings: End Cap #RW-29: 21-00-235 Wall Mount #RW-29: 21-00-230</p>	<p>2-5/8" x 1-1/2" Hollow Dixie Cap x 25' 10" 28-63-295 wt/ft: 0.569 <i>accepts 3/4" & 1" Pickets; 2 x 7/16" Channel; 2" Post; mates with 28-63-296</i></p>  <p>Accepts Castings: End Cap #RW-30: 21-00-245 Wall Mount #RW-30: 21-00-240</p>
<p>Outside Sleeve x 20' 28-63-291 wt/ft: 0.500 <i>mates with 28-63-290</i></p> 	<p>Outside Sleeve x 20' 28-63-296 wt/ft: 0.571 <i>mates with 28-63-295</i></p> 	

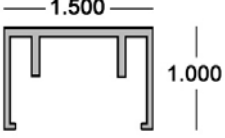
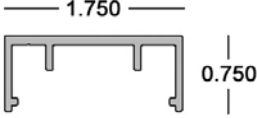
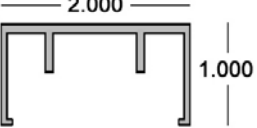
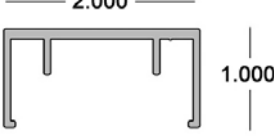

Railing Channel

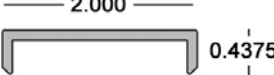
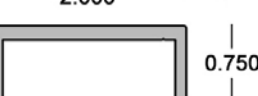
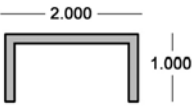
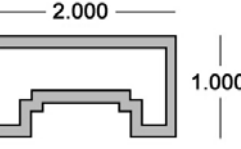
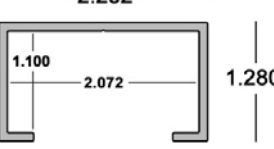
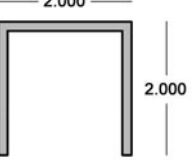
<p>1.5 x 1 (.093/.056) Railing Channel x 25' 13-63-300 wt/ft: 0.332 6063-T5 Receives .750 picket; Mates with 13-63-305</p>  <p>Accepts Casting: Wall Mount HR-12A #68: 21-00-183</p>	<p>1.75 x .75 (.093/.062) Railing Channel x 24' 13-63-264 wt/ft: 0.330 6063-T5 Receives .750 picket;</p> 	<p>2 x 1 (.093/.056) Railing Channel x 25' 13-63-266 wt/ft: 0.395 6063-T5 Receives .750 picket; Mates with 13-63-227</p> 	<p>2 x 1 (.090/.056) Railing Channel x 25' 13-63-267 wt/ft: 0.395 6063-T5 Receives 1" picket; Mates with 13-63-227</p>  <p>Accepts Casting: Wall Mount #15: 21-00-190</p>
<p>1.5" Railing Channel Cover Plate x 20' 13-63-305 wt/ft: 0.146 6063-T5 Mates with 13-63-300</p> 	<p>2" Railing Channel Cover Plate x 16' 13-63-227 wt/ft: 0.175 6063-T5 Mates with 13-63-266 & 13-63-267</p> 	<p>2 x 7/16 x .093 Railing Channel x 25' 2" 13-63-261 wt/ft: 0.294 6063-T5 No Legs</p> 	<p>2 x .75 (.125/.093) Railing Channel x 23' 10" 13-63-262 wt/ft: 0.440 6063-T5 No Legs</p> 
<p>2 x 1 x .125 Channel 13-63-265 x 20' 13-63-274 x 24' wt/ft: 0.563 6063-T5</p> 	<p>2 x 1 Mid Rail Tube x 24' 52-63-11317 wt/ft: 0.858 6063-T52</p>  <p>Accepts Casting: Wall Mount #15: 21-00-190</p>	<p>2.252 x 1.280 Outside Sleeve x 12' 52-63-4808 wt/ft: 0.562 6063-T6 Sleeves 2 x 1 Channel and Rectangular Tube</p> 	<p>2 x 2 x .125 Channel x 20' 13-63-272 wt/ft: 0.861 6063-T5</p> 

Pre-Punched Arch Aluminum Railing Channel (Mill Finish 6063-T6)

Stock Code	Size in Inches	Picket	
13-63-26620P*	2 x 1 x .093/.056 x 20'	3/4"	 <p>3.75" spacing between holes inside edge to inside edge</p>
13-63-265P	2 x 1 x .125 x 20' (6063 T5)	3/4"	
13-63-26720P*	2 x 1 x .093/.056 x 20'	1"	
13-63-274PP	2 x 1 x .125 x 24'	1"	

*with welding legs **for pickets with radius corners

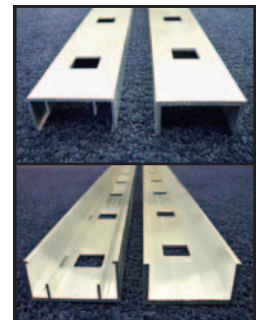

Stairwell Punched Channels (Mill Finish 6063-T6)

13-63-26620SWP	2 x 1 x .093/.056 x 20'	3/4"
13-63-265SWP1	2 x 1 x .125 x 20' (6063 T5)	3/4"
13-63-26720SWP	2 x 1 x .093/.056 x 20'	1"
13-63-265SWP2	2 x 1 x .125 x 20' (6063 T5)	1"

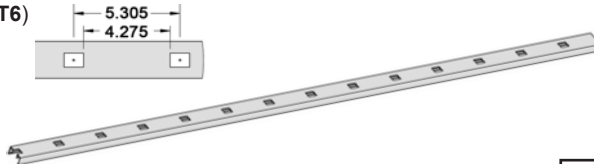

Picket Spears (Mill Finish 6063-T52)

19-63-105PS1	3/4 x .062 x 58"	3/4" & 1" Spears
19-63-105PS2	3/4 x .062 x 70"	
19-63-130PS1	1 x .060 x 58"	
19-63-130PS2	1 x .060 x 70"	

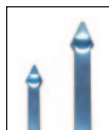

3.75 Decorative Aluminum Rings Casting
21-00-377

Custom sizes and hole locations available as **SPECIAL ORDER**

Mill Order Items: Not in Stock - Custom Sizes & Lengths Available Minimum Order Required



EASTERN METAL SUPPLY
FL: 800-432-2204 • NC/DE/GA: 800-343-8154 • TX/LA: 800-996-6061 • MO/OH/IN: 888-822-6061

RAILING & FENCE 08
02/02/24

www.easternmetal.com



Pipe Brackets (See Standards 23-24 for full selection of Pipe)

	2.25" x 3.875" Centerline Projected Pipe Bracket x 16' 31-63-135 163 wt/ft: 1.940		2.50" x 3.875" Centerline Projected Pipe Bracket x 16' 31-63-120 162 wt/ft: 2.012	
--	---	--	---	--

2.875" x 3.50" Centerline Projected Pipe Bracket x 16' 31-63-105 160 wt/ft: 1.853	2.50" x 4.375" Centerline Projected Pipe Bracket x 16' 31-63-140 164 wt/ft: 2.154	3.080" x 3.875" Centerline Projected Pipe Bracket x 16' 31-61-145 165 wt/ft: 2.1815	3.125" x 4.375" Centerline Projected Pipe Bracket x 12' 31-61-150 wt/ft: 2.264 Meets NFPA 101 Life Safety Code

Grip Rail Polished & Anodized Stock Code Length GR-12 12" GR-14 14" GR-18 18" GR-24 24" GR-36 36"		Grip Rail Mill Finish Stock Code Length GRM-12 12" GRM-14 14" GRM-18 18" GRM-24 24" GRM-36 36"		Mark 5 Gate Hinge* 52-63-8793 (Heavy Duty) with base plate *up to 800 lb load		Mark 4 Gate Hinge 52-63-9150 (Heavy Duty) without base plate		Gate Hinge Bearing GATE-BEARING 1 piece For use with Mark 4 and Mark 5 Gate Hinges	
--	--	---	--	--	--	--	--	---	--

SCH 40 Aluminum Pipe End Caps <table border="0"> <tr> <td>Mill Finish</td> <td>Pipe Size</td> </tr> <tr> <td>APC-100-MF</td> <td>1</td> </tr> <tr> <td>APC-125-MF</td> <td>1-1/4</td> </tr> <tr> <td>APC-150-MF</td> <td>1-1/2</td> </tr> <tr> <td>APC-200-MF</td> <td>2</td> </tr> <tr> <td>Anodized</td> <td></td> </tr> <tr> <td>APC-750</td> <td>3/4</td> </tr> <tr> <td>APC-100</td> <td>1</td> </tr> <tr> <td>APC-125</td> <td>1-1/4</td> </tr> <tr> <td>APC-150</td> <td>1-1/2</td> </tr> <tr> <td>APC-200</td> <td>2</td> </tr> <tr> <td>Black Plastic</td> <td></td> </tr> <tr> <td>RN1-1/4DBK1</td> <td>1</td> </tr> </table>	Mill Finish	Pipe Size	APC-100-MF	1	APC-125-MF	1-1/4	APC-150-MF	1-1/2	APC-200-MF	2	Anodized		APC-750	3/4	APC-100	1	APC-125	1-1/4	APC-150	1-1/2	APC-200	2	Black Plastic		RN1-1/4DBK1	1	SCH 40 Pipe x 24' - T4 Temper (for bending) <table border="0"> <tr> <td>Stock Code</td> <td>Size in Inches</td> </tr> <tr> <td>18-63-231</td> <td>1-1/4 x 1.660 OD x 1.380 ID x .140 Wall</td> </tr> <tr> <td>18-T4-500</td> <td>1-1/2 x 1.900 OD x 1.610 ID x .145 Wall</td> </tr> </table> <p>Many other Pipe sizes, Alloys & Temper are Available</p> <p>Pipe Inserts (6063-T52)</p> <table border="0"> <tr> <td>18-63-259</td> <td>1-1/4</td> <td>SCH 40 x 10'</td> </tr> <tr> <td>18-63-260</td> <td>1-1/2</td> <td>SCH 40 x 10'</td> </tr> <tr> <td>51-00-051</td> <td>1-3/8</td> <td>Serrated Tube x 20' (insert for 1-1/4 pipe)</td> </tr> </table>	Stock Code	Size in Inches	18-63-231	1-1/4 x 1.660 OD x 1.380 ID x .140 Wall	18-T4-500	1-1/2 x 1.900 OD x 1.610 ID x .145 Wall	18-63-259	1-1/4	SCH 40 x 10'	18-63-260	1-1/2	SCH 40 x 10'	51-00-051	1-3/8	Serrated Tube x 20' (insert for 1-1/4 pipe)	
Mill Finish	Pipe Size																																										
APC-100-MF	1																																										
APC-125-MF	1-1/4																																										
APC-150-MF	1-1/2																																										
APC-200-MF	2																																										
Anodized																																											
APC-750	3/4																																										
APC-100	1																																										
APC-125	1-1/4																																										
APC-150	1-1/2																																										
APC-200	2																																										
Black Plastic																																											
RN1-1/4DBK1	1																																										
Stock Code	Size in Inches																																										
18-63-231	1-1/4 x 1.660 OD x 1.380 ID x .140 Wall																																										
18-T4-500	1-1/2 x 1.900 OD x 1.610 ID x .145 Wall																																										
18-63-259	1-1/4	SCH 40 x 10'																																									
18-63-260	1-1/2	SCH 40 x 10'																																									
51-00-051	1-3/8	Serrated Tube x 20' (insert for 1-1/4 pipe)																																									

CENTERLINE GLASS RAILING - NEW!

2.5" Post System

Mechanical/Welded Combo
Accepts 7/16" and 9/16" Glass
Tested & Engineered System



**NOW OFFERING:
CARDINAL GLASS!**

For more information:
glass@easternmetal.com

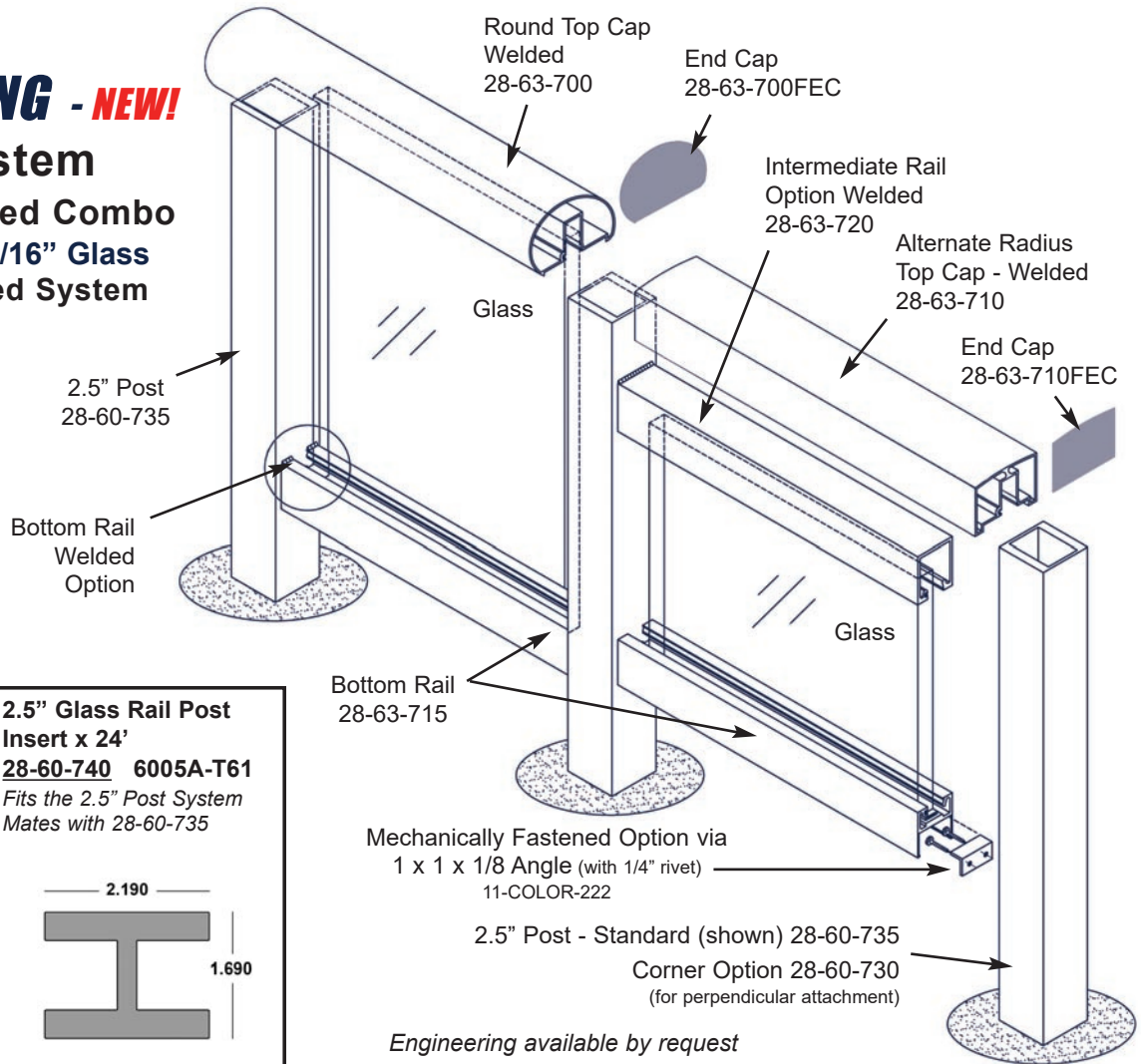

2.5" Glass Rail Inline Post x 24'
28-60-735 6005A-T61
Mates with 28-60-740; Fits the 2.5" Post System

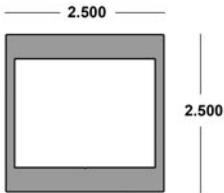

2.5" Glass Rail Post Insert x 24'
28-60-740 6005A-T61
Fits the 2.5" Post System Mates with 28-60-735

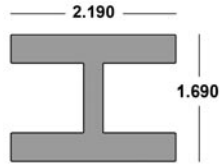

2.5" Glass Rail Corner Post x 24'
28-60-730 6005A-T61
Fit the 2.5" Post System

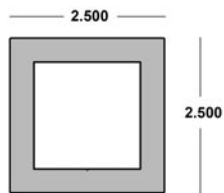

2.5" x 4.9" Glass Rail 135° Post x 24'
28-60-770 6005A-T61
Fits the 2.5" Post System

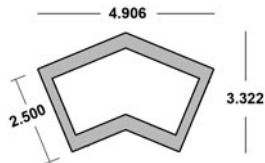

Alternate Radius Glass Rail Top Cap x 24'
28-63-710 6063-T6
Fits the 2.5" Post System
28-63-710FEC End Cap

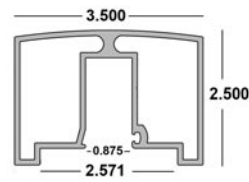

Top Cap End Caps
28-63-710FEC End Cap
Fits **28-63-710**



28-63-700FEC End Cap
Fits **28-63-700**



2" x 2.25" Intermediate Glass Rail x 24'
28-63-720 6063-T6
Fits the 2.5" & 3.5" Post Systems

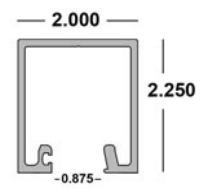

3.5" Round Glass Rail Top Cap x 24'
28-63-700 6063-T6
Fits the 2.5" Post System
28-63-700FEC End Cap

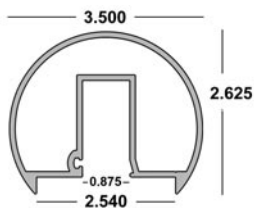

Round Glass Rail Inner Sleeve x 10'
52-63-8915 6063-T6
Fits the 2.5" Post System Mates with 28-63-700

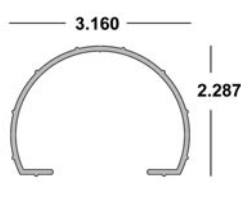

2" Centerline Glass Rail Bottom Channel x 24'
28-63-715 6063-T6
Fits the 2.5" & 3.5" Post Systems; Welded & Mechanical applications; Accepts 1 x 1 x 1/8 Angle 11-COLOR-222; Mates with 52-63-11327

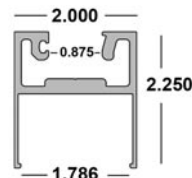

2" Centerline Glass Rail Bottom Channel x 24'
28-63-716 6063-T6
Fits the 2.5" & 3.5" Post Systems; Welded & Mechanical applications; Accepts 1 x 1 x 1/8 Angle 11-COLOR-222; Mates with 52-63-11327

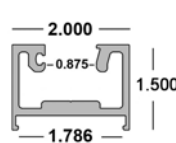

Cover Plate for Bottom Channel x 16'
52-63-11327 6063-T6
Fits the 2.5" & 3.5" Post Systems; Mates with 28-63-715, 28-63-716

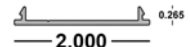

CENTERLINE GLASS RAILING - NEW!

3.5" Post System

Mechanical/Welded Combo
Accepts 7/16" and 9/16" Glass
Tested and Engineered System



**NOW OFFERING:
CARDINAL GLASS!**

For more information:
glass@easternmetal.com

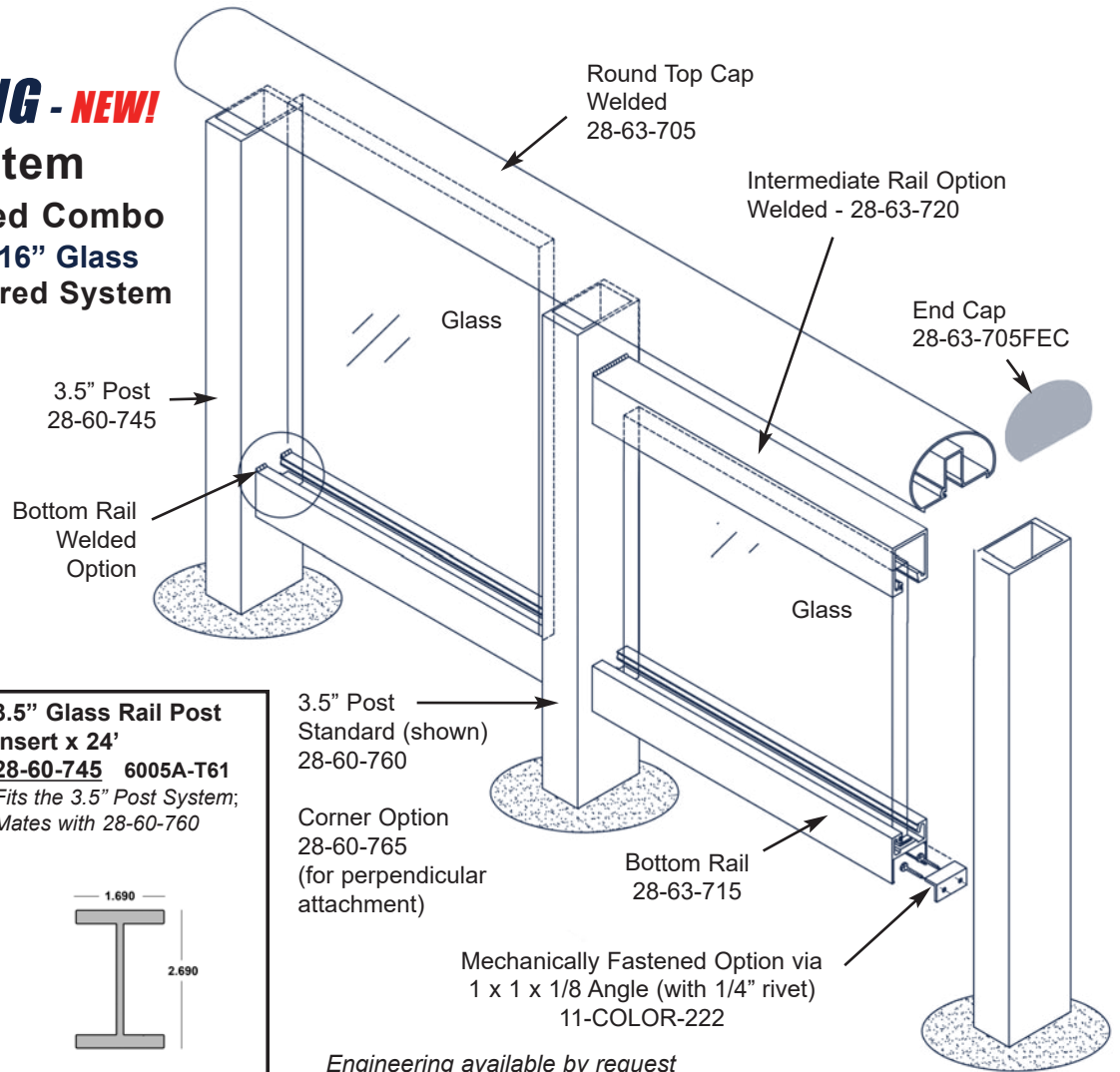

3.5" x 2" Glass Rail Inline Post x 24'
28-60-760 6005A-T61
Fits the 3.5" Post System;
Mates with I-Bar Post Insert 28-60-745

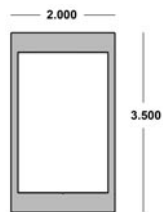

3.5" Glass Rail Post Insert x 24'
28-60-745 6005A-T61
Fits the 3.5" Post System;
Mates with 28-60-760

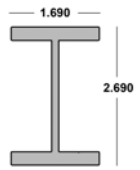

3.5" Post Standard (shown) 28-60-760

Corner Option 28-60-765 (for perpendicular attachment)

3.5" x 3.5" x .230" Glass Rail Corner Post x 24'
28-60-765 6005A-T61
Fits the 3.5" Post System; Mates with 3" Sq Tube Post Insert 52-61-750

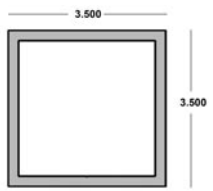

3" Square Tube Post Insert x 18'
52-61-750 6061-T6
Fits the 3.5" Post System;
Mates with 28-60-765

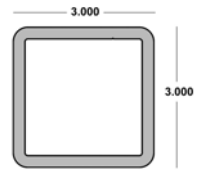

3.5" x 5.47" Glass Rail 135° Post x 24'
28-60-775 6005A-T61
Fits the 3.5" Post System

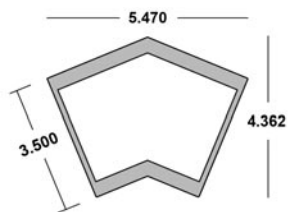

2" x 2.25" Intermediate Glass Rail x 24'
28-63-720 6063-T6
Fits the 2.5" & 3.5" Post Systems

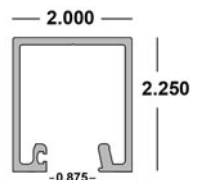

4.5" Round Glass Rail Top Cap x 24'
28-63-705 6063-T6
Fits the 3.5" Post System
28-63-705FEC End Cap

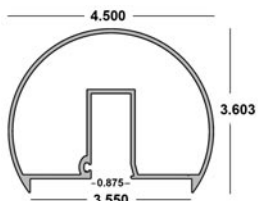

Top Cap End Cap 28-63-705FEC End Cap
Fits **28-63-705**



2" Centerline Glass Rail Bottom Channel x 24'
28-63-716 6063-T6
Fits the 2.5" & 3.5" Post Systems; Welded & Mechanical applications; Accepts 1 x 1 x 1/8 Angle 11-COLOR-222; Mates with 52-63-11327

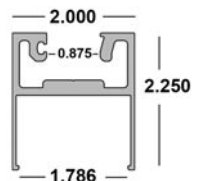

Cover Plate for Bottom Channel x 16'
52-63-11327 6063-T6
Fits the 2.5" & 3.5" Post Systems; Mates with 28-63-715

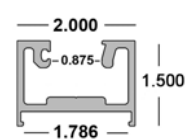

Cover Plate for Bottom Channel x 16'
52-63-11327 6063-T6
Fits the 2.5" & 3.5" Post Systems; Mates with 28-63-715, 28-63-716

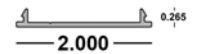

EASTERN METAL SUPPLY

FL: 800-432-2204 • NC/DE/GA: 800-343-8154 • TX/LA: 800-996-6061 • MO/OH/IN: 888-822-6061

RAILING & FENCE 11
02/04/24

www.easternmetal.com



60" ROOFTOP CENTERLINE GLASS RAILING - NEW!

3.5" Post System
Mechanical/Welded Combo
 Accepts 7/16" and 9/16" Glass
 Tested and Engineered System



NOW OFFERING:

CARDINAL GLASS!

For more information:
glass@easternmetal.com

**See engineering for post insert concrete embedment depth*

3" Post Insert
 52-61-750
 30" Minimum Height*

3.5" Post
 28-60-765

Round Top Cap
 Welded
 28-63-705

End Cap
 28-63-705FEC

3" Post Inserts
 52-61-750
 30" Minimum Height*

Glass

Glass

Bottom Rail
 28-63-715

Mechanically Fastened via
 1 x 1 x 1/8 Angle (with 1/4" rivet)
 11-COLOR-222

3.5" Post
 28-60-765

Engineering available by request

**3.5" x 3.5" x .230" Glass Rail
 Corner Post x 24'**
28-60-765 6005A-T61
*Fits the 3.5" Post System; Mates
 with 3" Sq Tube Post Insert
 52-61-750*

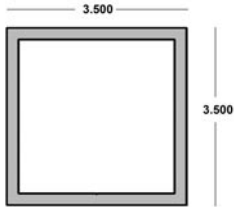

**3" Square Tube Post Insert x
 18'**
52-61-750 6061-T6
*Fits the 3.5" Post System;
 Mates with 28-60-765*

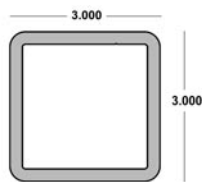

**4.5" Round Glass Rail
 Top Cap x 24'**
28-63-705 6063-T6
*Fits the 3.5" Post System
 28-63-705FEC End Cap*

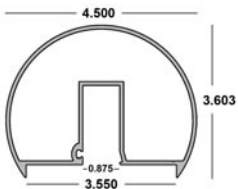

**Top Cap End Cap
 28-63-705FEC End Cap**
Fits 28-63-705

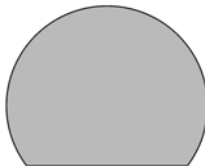

**2" Centerline Glass Rail
 Bottom Channel x 24'**
28-63-715 6063-T6
*Fits the 2.5" & 3.5" Post Systems;
 Welded & Mechanical applications;
 Accepts 1 x 1 x 1/8 Angle
 11-COLOR-222; Mates with
 52-63-11327*

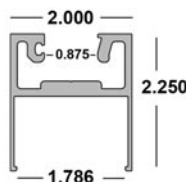

**2" Centerline Glass Rail
 Bottom Channel x 24'**
28-63-716 6063-T6
*Fits the 2.5" & 3.5" Post Systems;
 Welded & Mechanical applications;
 Accepts 1 x 1 x 1/8 Angle
 11-COLOR-222; Mates with
 52-63-11327*

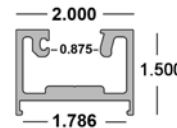

**Cover Plate for Bottom
 Channel x 16'**
52-63-11327 6063-T6
*Fits the 2.5" & 3.5" Post
 Systems; Mates with
 28-63-715, 28-63-716*

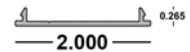

EASTERN METAL SUPPLY

FL: 800-432-2204 • NC/DE/GA: 800-343-8154 • TX/LA: 800-996-6061 • MO/OH/IN: 888-822-6061

RAILING & FENCE 12
 02/04/24

www.easternmetal.com



OFFSET GLASS RAILING - NEW!

2.5" Post System
Mechanical/Welded Combo
 Accepts 7/16" and 9/16" Glass
 Tested and Engineered System



NOW OFFERING:
CARDINAL GLASS!

For more information:
glass@easternmetal.com

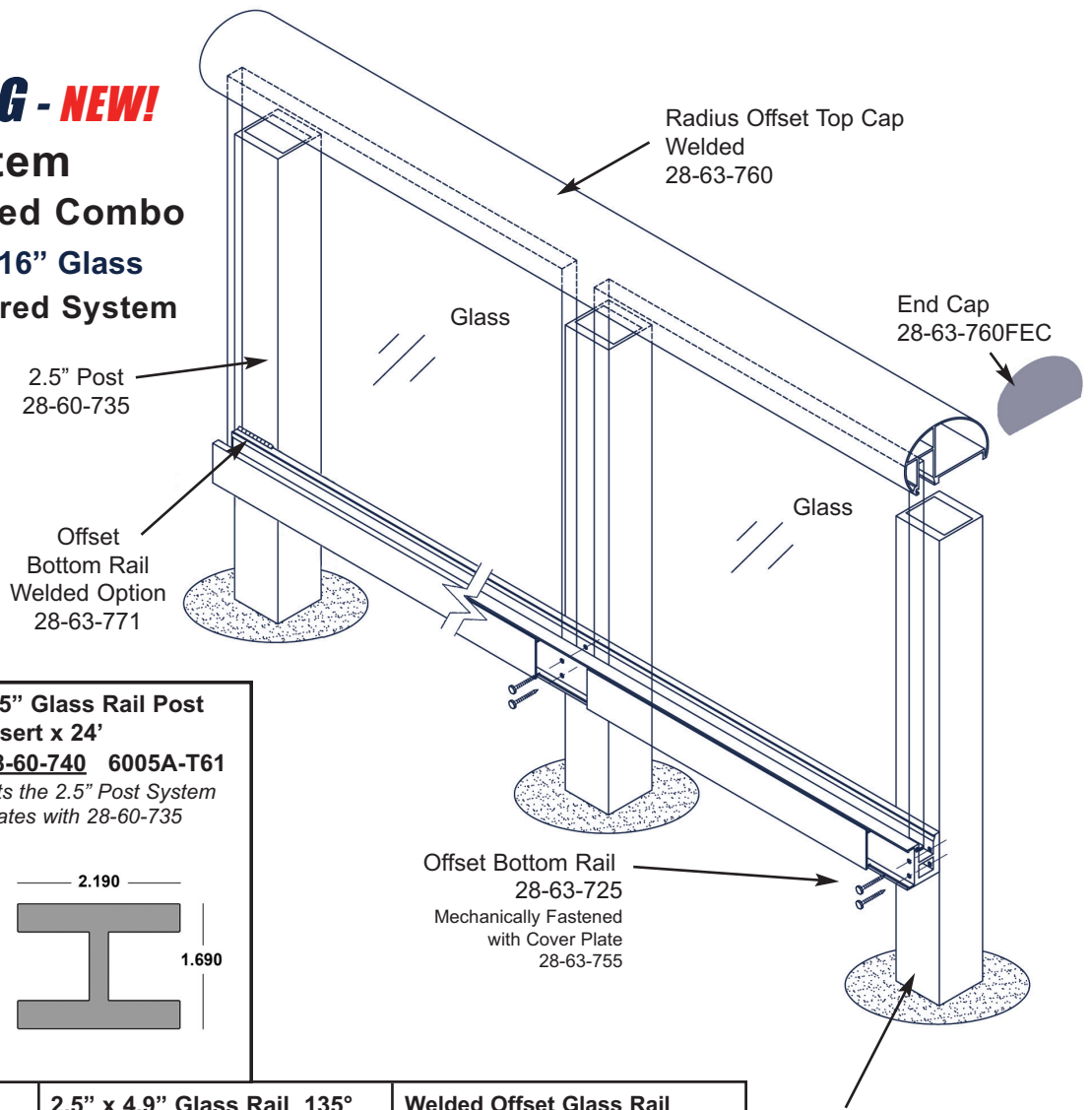

2.5" Post - Standard (shown)
 28-60-735
 Corner Option 28-60-730
 (for perpendicular attachment)
 Engineering available
 by request

2.5" Glass Rail Inline Post x 24'
28-60-735 6005A-T61
 Mates with 28-60-740; Fits the 2.5" Post System

2.5" Glass Rail Post Insert x 24'
28-60-740 6005A-T61
 Fits the 2.5" Post System Mates with 28-60-735

2.5" Glass Rail Corner Post x 24'
28-60-730 6005A-T61
 Fit the 2.5" Post System

2.5" x 4.9" Glass Rail 135° Post x 24'
28-60-770 6005A-T61
 Fits the 2.5" Post System

Welded Offset Glass Rail Bottom Channel x 24'
28-63-771 6063-T6
 Fits the 2.5" & 3.5" Post Systems

5" Radius Offset Glass Rail Top Cap x 24'
28-63-760 6063-T6
 Fits the 2.5" Post System
28-63-760FEC End Cap

Top Cap End Cap
28-63-760FEC End Cap
 Fits **28-63-760**

Cover Plate for Offset Bottom Channel x 24'
28-63-755 (Mechanical) 6063-T6
 Fits the 2.5" & 3.5" Post Systems
 Mates with 28-63-725

Mechanical Offset Glass Rail Bottom Channel x 24'
28-63-725 6063-T6 Fits the 2.5" & 3.5" Post Systems; Mates with 28-63-725



EASTERN METAL SUPPLY
 FL: 800-432-2204 • NC/DE/GA: 800-343-8154 • TX/LA: 800-996-6061 • MO/OH/IN: 888-822-6061

RAILING & FENCE 13
 09/19/22

www.easternmetal.com



OFFSET GLASS RAILING - NEW!

3.5" Post System
Mechanical/Welded Combo
 Accepts 7/16" and 9/16" Glass
 Tested and Engineered System



NOW OFFERING:
CARDINAL GLASS!

For more information:
glass@easternmetal.com

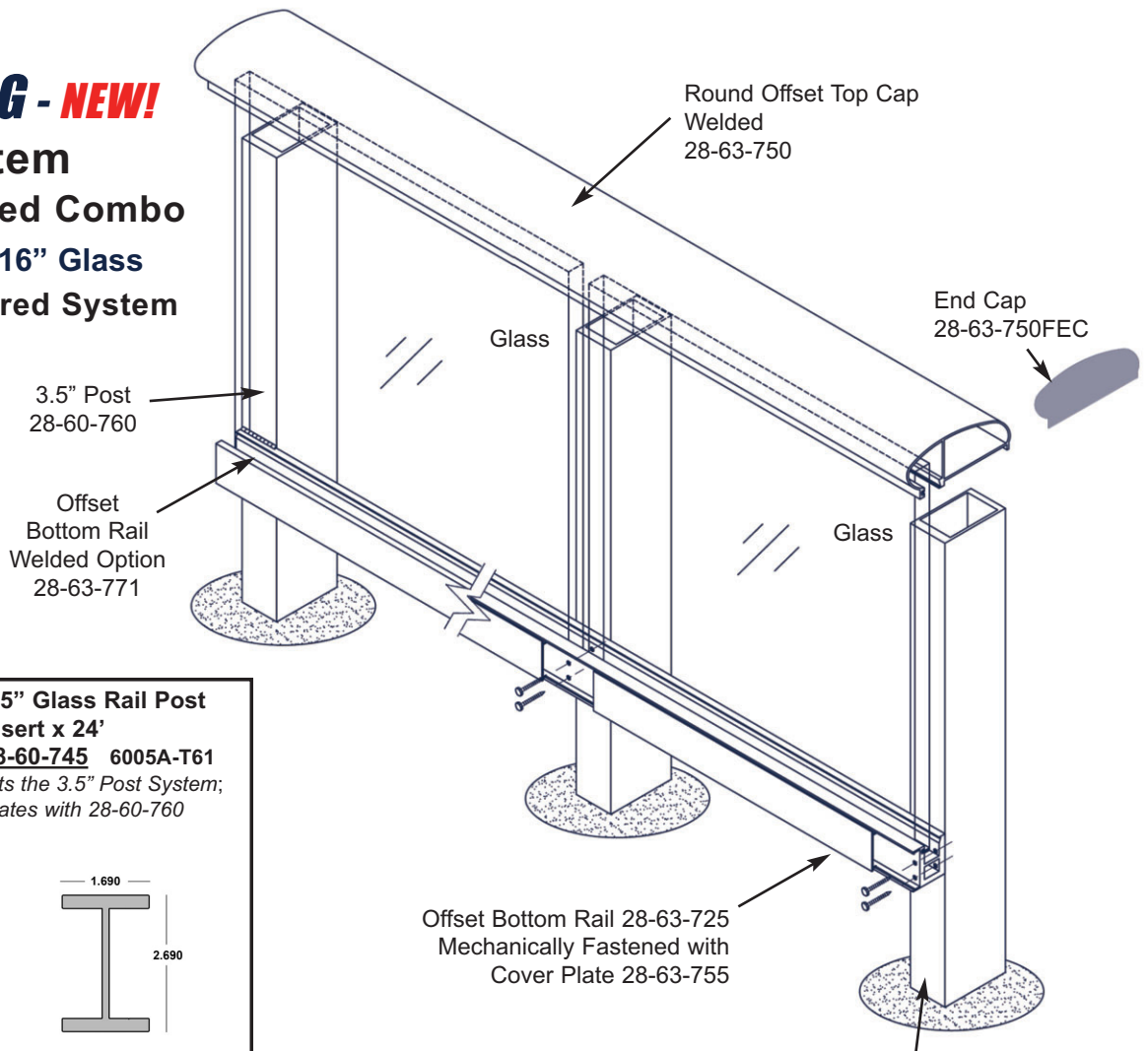

3.5" x 2" Glass Rail Inline Post x 24'
28-60-760 6005A-T61
Fits the 3.5" Post System; Mates with I-Bar Post Insert 28-60-745

3.5" Glass Rail Post Insert x 24'
28-60-745 6005A-T61
Fits the 3.5" Post System; Mates with 28-60-760

3.5" x 3.5" Glass Rail Corner Post x 24'
28-60-765 6005A-T61
Fits the 3.5" Post System; Mates with 3" Sq Tube Post Insert 52-61-750

3" Square Tube Post Insert x 18'
52-61-750 6061-T6
Fits the 3.5" Post System; Mates with 28-60-765

3.5" x 5.47" Glass Rail 135° Post x 24'
28-60-775 6005A-T61
Fits the 3.5" Post System

6" Radius Offset Glass Rail Top Cap x 24'
28-63-750 6063-T6
Fits the 3.5" Post System
28-63-750FEC End Cap

Top Cap End Cap 28-63-750FEC
 End Cap
 Fits **28-63-750**

Cover Plate for Offset Bottom Channel x 24'
28-63-755 (Mechanical) 6063-T6
Fits the 2.5" & 3.5" Post Systems; Mates with 28-63-725

Mechanical Offset Glass Rail Bottom Channel x 24'
28-63-725 6063-T6
Fits the 2.5" & 3.5" Post Systems; Mates with 28-63-755

Welded Offset Glass Rail Bottom Channel x 24'
28-63-771 6063-T6
Fits the 2.5" & 3.5" Post Systems; Mates with 28-63-755



GLASS RAILING GLAZING - NEW!

For 7/8 Glass Pockets using 7/16" and 9/16" Glass

Used with our Tested and Engineered Systems (Fence & Railing 10-14)

LAMINATED GLASS (sized by order) - *Now available from Eastern Metal Supply!*



- 7/16" Laminated Glass with vertical polished edge
- 0.035 SGP between 3/16" Tempered Glass • Design Pressure = +/-130
- 9/16" Laminated Glass with vertical polished edge
- 0.035 SGP between 1/4" Tempered Glass • Design Pressure = +/-190

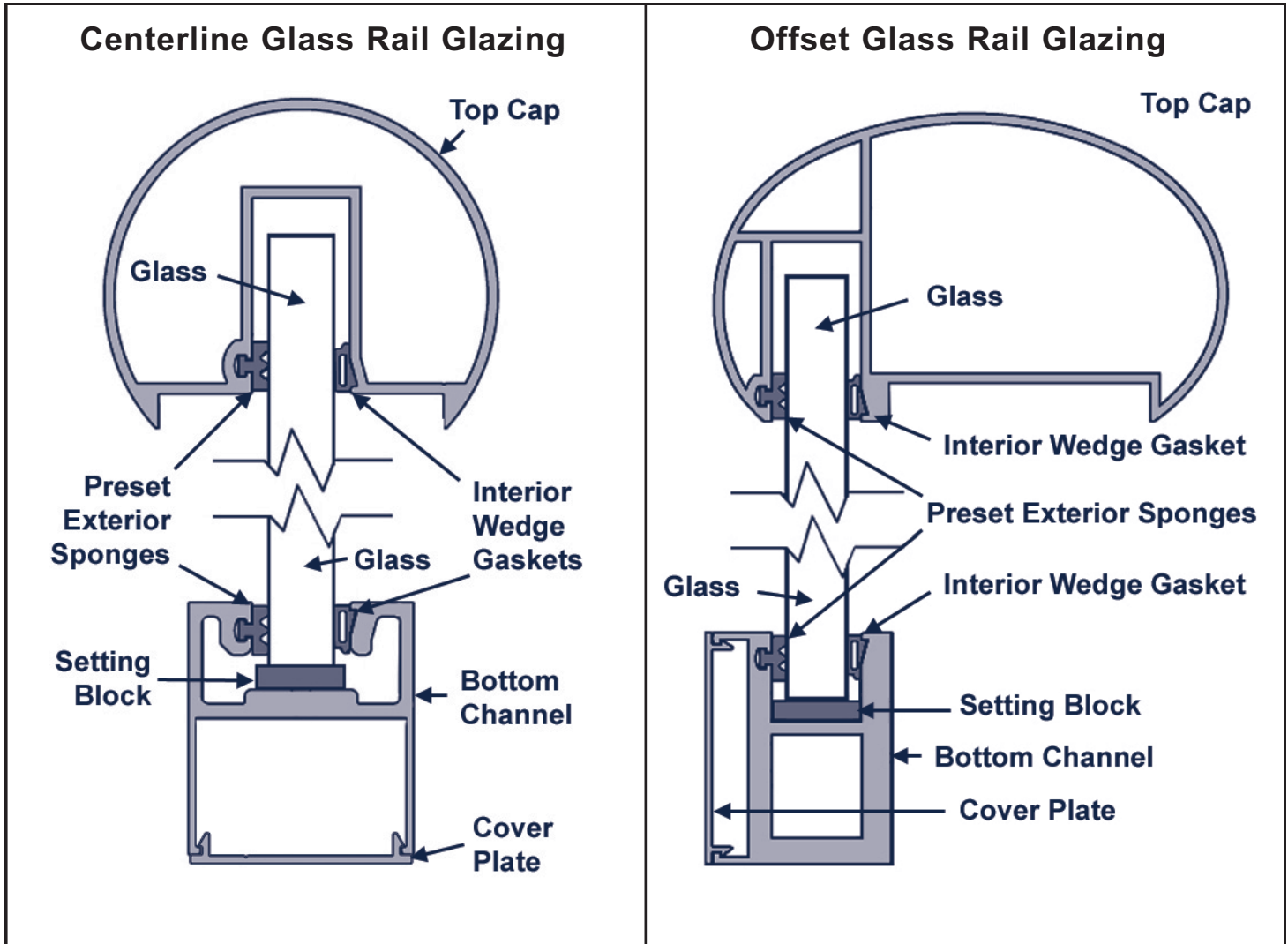

NOW OFFERING:
CARDINAL
GLASS!

For more information:
glass@easternmetal.com

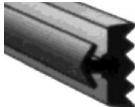

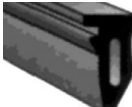
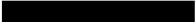
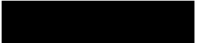
<p>Preset Exterior Sponge - 250' rolls WW-B090 (sponge) Santoprene Gasket .125 face clearance, .250 centerline 9/16" Glass</p> 	<p>Preset Exterior Sponge - 250' rolls WW-B140 (sponge) Santoprene Gasket .250 face clearance, .250 centerline 7/16" Glass</p> 	<p>Interior Wedge Gaskets - 250' rolls WW-W514 Santoprene Gasket .187 face clearance, .062 nub Both Glass Types</p> 	<p>Centerline Neoprene Setting Block WW-BN02164 1/8 x 1 x 4</p> 	<p>Offset Neoprene Setting Block WW-BN04164 1/4 x 1 x 4</p> 
---	---	--	--	--



EASTERN METAL SUPPLY
RAILING & FENCE 15 09/19/22
www.easternmetal.com
FL: 800-432-2204 • NC/DE/GA: 800-343-8154 • TX/LA: 800-996-6061 • MO/OH/IN: 888-822-6061

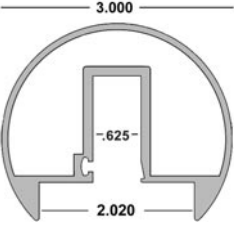
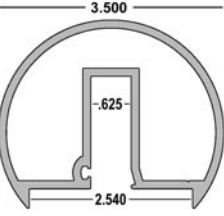
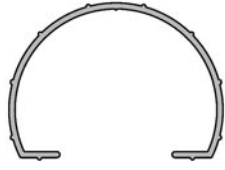
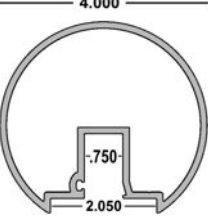
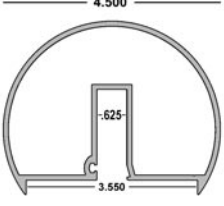
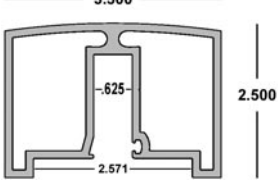
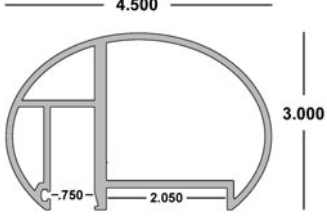
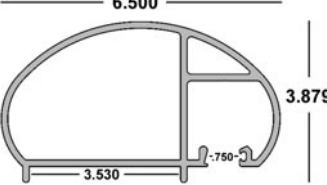
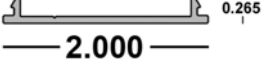
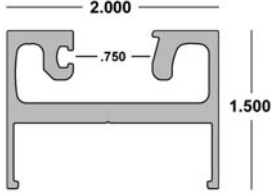
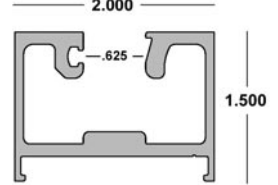
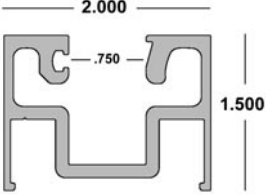
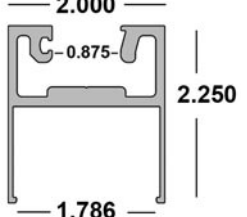
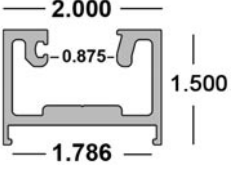
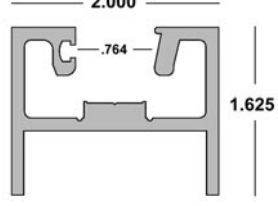

<p>3" Round Glass Cap MILL ORDER 52-63-12183 - GR104 <i>wall:0.125; with 1.500 deep glass pocket</i></p> 	<p>3-1/2" Round Glass Cap X 24' 52-63-10740 - GR108 <i>wall:0.125; with 1.750 deep glass pocket</i> <i>Mates with GRS110</i></p> 	<p>Glass Rail Inner Sleeve x 10' - RS110 52-63-8915 <i>wall:0.090</i> <i>Mates with GR108</i></p> 
<p>4" Round Glass Cap MILL ORDER 52-63-9402 - GR116 <i>wall:0.125; with 1.250 deep glass pocket</i> <i>Accepts 2" Post</i></p> 	<p>4-1/2" Round Top Cap MILL ORDER 52-63-11470 - GR118 <i>wall:0.105; with 1.750 deep glass pocket</i> <i>Mates with GR312 (3.5" Post)</i></p> 	<p>3-1/2" x 2-1/2" Rect Glass Top Cap MILL ORDER 52-63-11065 - GR122 <i>wall:0.125; with 1.680 deep glass pocket</i> <i>Accepts 2.5" Post</i></p> 
<p>4-1/2" Offset Oval Glass Cap MILL ORDER 52-63-13034 - GR300 <i>wall:0.110; with 1.75 deep glass channel</i> <i>Accepts 2" Post</i></p> 	<p>6-1/2" x 3-3/4" Offset Oval Glass Rail Cap - GR304 MILL ORDER 52-63-8500 <i>wall:0.150</i> <i>with 2.00 deep glass channel; Mates with GR312 (3.5" Post)</i></p> 	<p>Cover Plate x 16' - GRC214 52-63-11327 <i>wall:0.090</i> <i>mates with GRC202, GRC204, GRC210 and 28-63-715</i></p> 
<p>2" x 1-1/2" Glass Bottom Channel x 24' MILL ORDER 52-63-10348 - GRC202 <i>wall:0.090; with 0.687 deep glass pocket;</i> <i>mates with GRC214</i></p> 	<p>2" x 1-1/2" Glass Bottom Channel x 24' - GRC204 52-63-10741 <i>wall:0.090</i> <i>with 1" deep glass pocket; Can be used as a Mid Rail when inverted; mates with GRC214</i></p> 	<p>2" x 1-1/2" Mid Rail Glass Channel x 24' - GRC210 MILL ORDER 52-63-9940 <i>wall:0.090</i> <i>with 1.250 deep glass pocket; mates with GRC214</i></p> 
<p>2" Centerline Glass Rail Bottom Channel x 24' 28-63-715 6005A-T61 <i>Mates with 52-63-11327</i></p> 	<p>2" Centerline Glass Rail Bottom Channel x 24' 28-63-716 6063-T6 <i>Mates with 52-63-11327</i></p> 	<p>2" x 1-5/8" Glass Bottom Channel MILL ORDER 52-63-12101 - GRC206 <i>wall:0.125; with 0.875 deep glass pocket</i></p> 

2-1/4" x 2" Glass Channel
MILL ORDER 52-63-13991 - GRC213
 wall:0.125; with 1.500 deep glass pocket

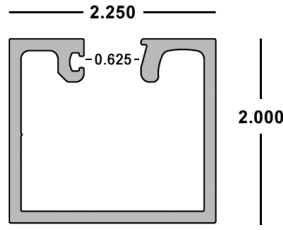

3-1/2" x 2-1/2" Offset Bottom Channel
MILL ORDER 52-63-13138 - GR310
 wall:0.090; with 1.75 deep glass channel

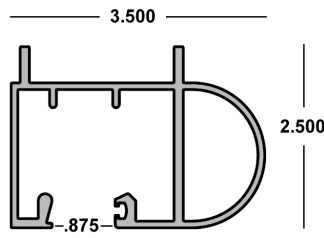

2" x 1-5/8" Mid Rail Glass Channel
MILL ORDER 52-63-12798 - GRC212
 wall:0.125; with 1.500 deep glass pocket

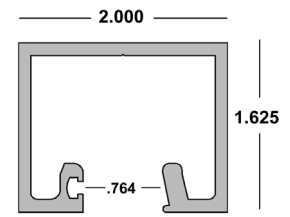

3.325" x 4.75" Glass Base Shoe x 10'
28-63-077
 with 3.980 deep glass pocket

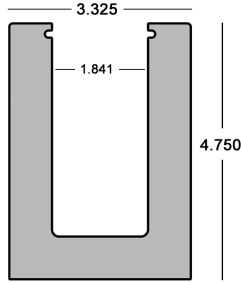

2.75" x 4.125" Glass Base Shoe x 20'
51-63-327
 with 3.125 deep glass pocket

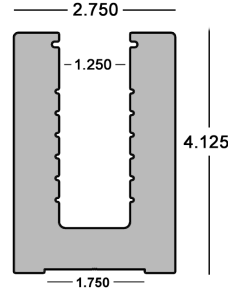

2.50" x 4" Glass Base Shoe x 20'
51-63-325
 with 3.125 deep glass pocket

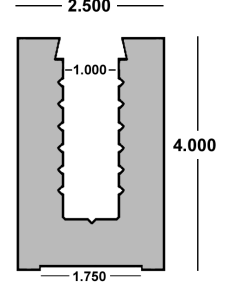

2.25" x 3" Glass Glass Base Shoe
MILL ORDER 52-63-10157
 wall:0.625 with 2.063 deep glass pocket

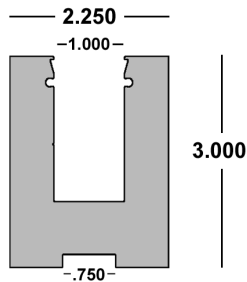

2.50" x 4" Glass Base Shoe x 20'
51-63-326 (TX)
 with 3.125 deep glass pocket
 Pre-Fabbed with 20 Holes

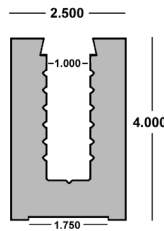

Glass Rail Post x 24'
20-61-270
 2 x 2-1/2 x 1/8 Rect Tube 6061 T6

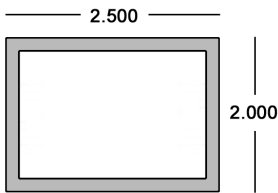

3.5" x 2" Heavy Duty Glass Rail Post
MILL ORDER 52-61-2056 - GR312
 wall:0.094; Receives 3/8" x 3" flat bar; Mates with GRC302 & GRC304

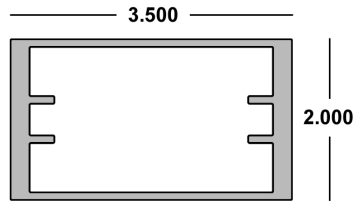

Glass Rail Post
 19-61-208 2 x .188 (6061-T6)
 19-61-212 2 x .250 (6061-T6)
 19-63-210 2 x .125
 19-61-210 2 x .125 (6061-T6)
 52-61-936 2 x .125 (6061-T6)
 19-63-211 2 x .188
 52-61-1128 2 x .188 w/rad (6061-T6)
 28-60-735 2.50 x .125/.375 (6005A-T61)
 28-60-730 2.50 x .375 (6005A-T61)
 MILL ORDER 2.50 x .188 (52-61-3402)
 28-60-760 3.50 x 2.00 x .125/.375 (6005A-T61)
 28-60-765 3.50 x .125 (6005A-T61)

2" Square Post Stiffener x 12'
52-61-2163 for 2" x .125 Sq Tube

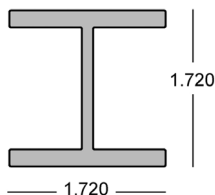

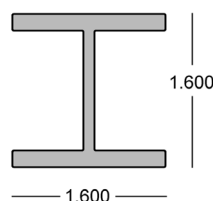

2" Square Post Stiffener x 12'
52-61-4452 for 2" x .188 Sq Tube



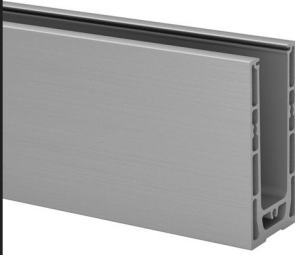
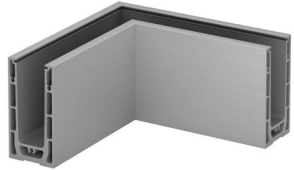

NOW OFFERING:
CARDINAL GLASS!
 For more information:
glass@easternmetal.com

BRUSHED ALUMINUM GLASS RAILING BASE SHOE

NOW STOCKING - Call your Sales Representative for more Information

<p>Easy Glass Smart Base Shoe Top Mount <u>70-70-10S</u> x 10' <u>70-70-20S</u> x 20' Brushed Aluminum Satin Anodized</p> 	<p>Easy Glass Smart Base Shoe Corner Top Mount <u>70-90-0TS</u> Brushed Aluminum Satin Anodized</p> 	<p>Easy Glass Smart End Cap Top Mount <u>70-50-00S</u> Left & Right; Brushed Aluminum Satin Anodized</p> 	<p>Easy Glass Smart Drainage Profile <u>70-69-48S</u> 4 pcs Brushed Aluminum Satin Anodized</p> 
---	---	--	---

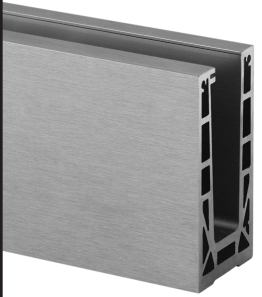
<p>Easy Glass Smart Base Shoe Fascia Mount <u>72-72-10S</u> x 10' <u>72-72-20S</u> x 20' Brushed Aluminum Satin Anodized</p> 	<p>Easy Glass Smart End Cap Fascia Mount <u>72-50-0LS</u> Left <u>72-50-0RS</u> Right Brushed Aluminum Satin Anodized</p> 	<p>Easy Glass Prime Blind Plug <u>99-33-333</u></p> 	<p>Easy Glass Smart Rubber Set Adjustable Includes 20' of both gaskets and 25 Discs <u>99-15L-20S</u> for 1/2" glass <u>99-916L-20S</u> for 9/16" glass</p> 	<p>Disc Adjusting Tool <u>77-084</u></p> 
--	--	---	--	---

<p>Easy Glass Max Base Shoe Top Mount <u>70-70-08M</u> x 8.2' Brushed Aluminum Satin Anodized</p> 	<p>Easy Glass Max Base Shoe Corner Top Mount <u>70-90-0TM</u> Brushed Aluminum Satin Anodized 2 pcs</p> 	<p>Easy Glass Max End Cap Top Mount <u>70-50-0TM</u> Left & Right; Brushed Aluminum Satin Anodized</p> 	<p>Rubber Set Easy Glass Max for 27/32LAM Includes 16' of both gaskets and 20 Wedges <u>99-2732-M</u> for 27/32" laminated glass</p> 	<p>Easy Glass Multitool <u>77-071</u></p> 
--	--	---	---	---



NOW OFFERING CARDINAL GLASS! Info: glass@easternmetal.com



EASTERN METAL SUPPLY
 RAILING & FENCE 18
 09/19/22
www.easternmetal.com
 FL: 800-432-2204 • NC/DE/GA: 800-343-8154 • TX/LA: 800-996-6061 • MO/OH/IN: 888-822-6061



316 STAINLESS STEEL ROUND POST CABLE RAILING











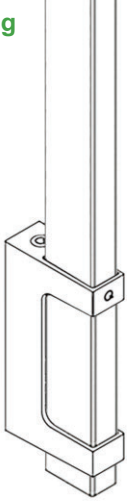



NOW STOCKING - Call your Sales Representative for more Information

<p>1.9" ROUND Stainless Steel Cable Railing Pre-fabricated Post - Floor Mount Accepts 1/8" or 5/32" Fast Fix Cable Sets Ø1.9" x 0.156" 36" Post (uses 10 Cables; 3" spacing) C8490814481 A, Anchor Post C8490834481 B, Center/Line Post C8490824481 C, Receiver Post C8490874481 90°, Corner Post</p> <p>42" Post (uses 12 Cables; 3" spacing) C8490914481 A, Anchor Post C8490934481 B, Center/Line Post C8490924481 C, Receiver Post C8490974481 90°, Corner Post</p> 		<p>1.9 ROUND Stainless Steel Cable Railing Pre-fabricated Post - Fascia Mount Accepts 1/8" or 5/32" Fast Fix Cable Sets Ø1.9" x 0.156" 36" Post (uses 10 Cables; 3" spacing) C8490314481 A, Anchor Post C8490334481 B, Center/Line Post C8490324481 C, Receiver Post</p> <p>42" Post (uses 12 Cables; 3" spacing) C8490414481 A, Anchor Post C8490434481 B, Center/Line Post C8490424481 C, Receiver Post</p> 		
<p>ROUND Stainless Steel Tube Ø1-1/2" x 0.078" 68-10-081 x 8.2' 68-10-161 x 16.4'</p> 	<p>Flush Elbow, 90° 68-91-001 Curved Stainless Steel 2 pcs</p> 	<p>Flush Elbow, 90° 68-90-001 Rounded Stainless Steel 2 pcs</p> 	<p>Adjustable Flush Angle (0°-70°) 68-90-A01 Stainless Steel 2 pcs</p> 	<p>Tube Connector, Easy Hit, Tube Ø1-1/2" x 0.078" 68-80-001 2 pcs</p> 
<p>Arched End Cap Easy Hit 68-5R-001 Stainless Steel 2 pcs</p> 	<p>Domed End Cap Easy Hit 68-5D-001 Stainless Steel 2 pcs</p> 	<p>Wall Flange 68-05-WF1 Stainless Steel 2 pcs</p> 	<p>Wall Flange with Blind Connection 68-00-WF1 2 pcs</p> 	<p>Hexagon Socket Button Head Screw 68-00-111 50 pcs</p> 
<p>Fast Fix Cable-Sets 1/8" Cable 68-125-08 x 8' 68-125-16 x 16.4' 68-125-24 x 24.5' 68-125-32 x 32.8' 68-125-41 x 41' 5/32" Cable 68-187-08 x 8' 68-187-16 x 16.4' 68-187-24 x 24.5' 68-187-32 x 32.8' 68-187-41 x 41'</p> 	<p>SS-Glue 1.69 fl.oz. 68-13-31</p> 	<p>SS-Cleaner 10.1 fl.oz. 68-88-23</p> 	<p>SS-Protector 16.9 fl.oz. 68-88-63</p> 	<p>Scotch-Brite 3M Abrasive Pad 68-88-25 10 pcs</p> 



316 STAINLESS STEEL RECTANGULAR POST CABLE RAILING

NOW STOCKING - Call your Sales Representative for more Information

<p>RECTANGULAR Stainless Steel Cable Railing Pre-fabricated Post - Floor & Fascia Mount Accepts 1/8" or 5/32" Fast Fix Cable Sets 2.36 x 1.18 x 0.1" 36" Post (uses 10 Cables; 3" spacing) C8490810631 A, Anchor Post C8490830631 B, Center/Line Post C8490820631 C, Receiver Post 42" Post (uses 12 Cables; 3" spacing) C8490910631 A, Anchor Post C8490930631 B, Center/Line Post C8490920631 C, Receiver Post</p> 	<p>RECTANGULAR Stainless Steel Tube 2.36" x 0.79" x 0.078" <u>68-10-082</u> x 8.2' <u>68-10-162</u> x 16.4'</p> 																										
<p>Adjustable Flush Angle Square Line (0°-70°) <u>68-90-A62</u> 2 pcs</p> 	<p>Flush Elbow Square Line, 90° <u>68-90-062</u> 2 pcs</p> 	<p>Tube Connector Square Line, Easy Hit <u>68-80-002</u> 2 pcs</p> 	<p>Wall Flange Square Line <u>68-00-WF2</u> 2 pcs</p> 																								
<p>Flat End Cap Square Line, Easy Hit <u>68-50-002</u> 2 pcs</p> 	<p>Handrail Bracket for Wall Mounting, M8 Thread <u>68-03-W01</u> 2 pcs</p> 	<p>Hanger Bolt <u>68-00-086</u> 50 pcs</p>  <p>Hexagon Socket Countersunk Head Screw <u>68-00-113</u> 50 pcs</p> 	<p>Fast Fix Cable-Sets</p> <table border="0"> <tr><td>1/8" Cable</td><td></td></tr> <tr><td><u>68-125-08</u></td><td>x 8'</td></tr> <tr><td><u>68-125-16</u></td><td>x 16.4'</td></tr> <tr><td><u>68-125-24</u></td><td>x 24.5'</td></tr> <tr><td><u>68-125-32</u></td><td>x 32.8'</td></tr> <tr><td><u>68-125-41</u></td><td>x 41'</td></tr> <tr><td>5/32" Cable</td><td></td></tr> <tr><td><u>68-187-08</u></td><td>x 8'</td></tr> <tr><td><u>68-187-16</u></td><td>x 16.4'</td></tr> <tr><td><u>68-187-24</u></td><td>x 24.5'</td></tr> <tr><td><u>68-187-32</u></td><td>x 32.8'</td></tr> <tr><td><u>68-187-41</u></td><td>x 41'</td></tr> </table> 	1/8" Cable		<u>68-125-08</u>	x 8'	<u>68-125-16</u>	x 16.4'	<u>68-125-24</u>	x 24.5'	<u>68-125-32</u>	x 32.8'	<u>68-125-41</u>	x 41'	5/32" Cable		<u>68-187-08</u>	x 8'	<u>68-187-16</u>	x 16.4'	<u>68-187-24</u>	x 24.5'	<u>68-187-32</u>	x 32.8'	<u>68-187-41</u>	x 41'
1/8" Cable																											
<u>68-125-08</u>	x 8'																										
<u>68-125-16</u>	x 16.4'																										
<u>68-125-24</u>	x 24.5'																										
<u>68-125-32</u>	x 32.8'																										
<u>68-125-41</u>	x 41'																										
5/32" Cable																											
<u>68-187-08</u>	x 8'																										
<u>68-187-16</u>	x 16.4'																										
<u>68-187-24</u>	x 24.5'																										
<u>68-187-32</u>	x 32.8'																										
<u>68-187-41</u>	x 41'																										
<p>SS-Glue 1.69 fl.oz. <u>68-13-31</u></p> 	<p>SS-Cleaner 10.1 fl.oz. <u>68-88-23</u></p> 	<p>SS-Protector 16.9 fl.oz. <u>68-88-63</u></p> 	<p>Scotch-Brite 3M Abrasive Pad <u>68-88-25</u> 10 pcs</p> 																								



Weldable BDA Pipe for Railing Applications



FEATURES & BENEFITS:

- Weldable Bright Dip Anodized Surface
- Requires no grinding or stripping before welding
- Anodized Material protects from the elements
- Available in Bright Polished or Bright Brushed
- Strong but also formable (Same pipe is used for towers on sport fishing boats which comes under significant torque etc.)
- Strength of the aluminum is comparable to 6063-T6
- BDA pipe provides an appearance similar to Stainless Steel but at a significantly lower price point
- This BDA pipe can be fabricated into cable rail systems
- In stock marine hardware may be adaptable to railing jobs
- Short lead times...material in stock
- Typical TIG welding wire used is 5356
- If desired, welds can be touched up with Sheffield Red Hot Aluminum Paint available from many local outlets



Weldable BDA Pipe for Railing Applications

High Quality Marine Pipe

6463 Pipe comes Boxed and Poly-Sleeved

POLISHED Bright Dipped Anodized SCH 40 Pipe x 23'

<u>WESTERN</u> (6463-T66)	<u>BON-L</u> (6463-T67)	<u>Size in Inches</u>	<u>Pcs/Box (Lin Ft/Box)</u>
Special Order	25-BD-100	1/2	16 (368')
25-BDW-105A*	25-BD-105A*	3/4	10 (230')
25-BDW-110A*	25-BD-110A*	1	6 (138')
25-BDW-115	25-BD-115	1-1/4	6 (138')
25-BDW-120	25-BD-120	1-1/2	5 (115')
25-BDW-125	25-BD-125	2	4 (92')
25-BDW-130	25-BD-130	2-1/2	2 (46')
25-BDW-135	Special Order	3	2 (46')

* Designed for 3/4" and 1" Sleeve Together - Pipe Aligners Available: Marine p15

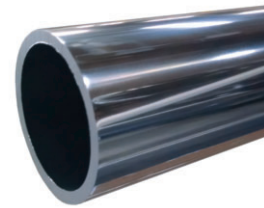

Polished and
Bright Dipped



Lite Brushed
and Bright Dipped

LITE BRUSHED Bright Dipped Anodized SCH 40 Pipe x 23' (320 grit)

<u>WESTERN</u> (6463-T66)	<u>BON-L</u> (6463-T67)	<u>Size in Inches</u>	<u>Pcs/Box (Lin Ft/Box)</u>
Special Order	25-BR-100	1/2	16 (368')
25-BRW-105B*	25-BR-105B*	3/4	10 (230')
25-BRW-110B*	25-BR-110B*	1	6 (138')
25-BRW-115	25-BR-115	1-1/4	6 (138')
25-BRW-120	25-BR-120	1-1/2	5 (115')
25-BRW-125	25-BR-125	2	4 (92')
25-BRW-130	25-BR-130	2-1/2	2 (46')
25-BRW-135	Special Order	3	2 (46')

* Designed for 3/4" and 1" Sleeve Together - Pipe Aligners Available: Marine p15

POLISHED Bright Dipped Anodized SCH 80 Pipe x 23'

<u>WESTERN</u> (6463-T66)	<u>BON-L</u> (6463-T67)	<u>Size in Inches</u>	<u>Pcs/Box (Lin Ft/Box)</u>
Special Order	26-BD-110	1	6 (138')
26-BDW-115	Special Order	1-1/4	6 (138')
26-BDW-120	26-BD-120	1-1/2	5 (115')
26-BD-125C	26-BD-125C	2	2 (46')
26-BDW-130	Special Order	2-1/2	2 (46')

LITE BRUSHED Bright Dipped Anodized SCH 80 Pipe x 23' (320 Grit)

<u>WESTERN</u> (6463-T66)	<u>BON-L</u> (6463-T67)	<u>Size in Inches</u>	<u>Pcs/Box (Lin Ft/Box)</u>
26-BRW-115	Special Order	1-1/4	6 (138')
26-BRW-120	Special Order	1-1/2	5 (115')
26-BRW-215	26-BR-215	2	4 (92')

SCH 40 Aluminum Pipe End Caps

Mill Finish

APC-100-MF	1	
APC-125-MF	1-1/4	
APC-150-MF	1-1/2	
APC-200-MF	2	

Anodized

APC-750	3/4	
APC-100	1	
APC-125	1-1/4	
APC-150	1-1/2	
APC-200	2	

SCH 40 Flat End Caps





FEC-100-MF	1"	
Mill Finish		



SCH 40 Black Plastic End Caps

RN1-1/4DBK1	1"	
RN1-1/4DBK1	1"	
RN1625DBK1	1-1/4"	

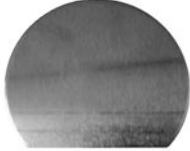

CASTINGS

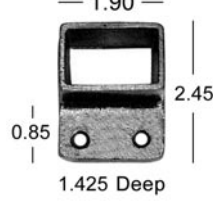
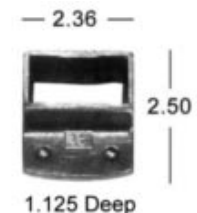
<p>HR1 End Cap 21-DC-100 Die Cast</p>  <p>Accepts: Top Cap - HR-1-COLOR</p>	<p>HR10 Flat End Cap 52-00-147 Sand Cast</p>  <p>Accepts: Top Cap - HR-10-COLOR</p>	<p>HR14 End Cap 21-00-114 Sand Cast</p>  <p>Accepts: Top Cap - HR-14-COLOR</p>	<p>Handicap Rail End Cap 21-DC-114 Die Cast</p>  <p>Accepts: Top Cap - HR-14-COLOR</p>	<p>2-1/4" x 6" End Cap 21-00-150 Sand Cast</p>  <p>Accepts: Top Cap - 28-63-260</p>																																		
<p>2-5/8" x 1" End Cap 21-00-135 Die Cast</p>  <p>Accepts: Hollow Cap #129 - 28-63-210 Hollow Cap #130 - 28-63-200</p>	<p>2-5/8" x 1-1/2" Flat End Cap 21-00-140F Sand Cast</p>  <p>Accepts: Hollow Cap #135 - 28-63-215</p>	<p>2-5/8" x 1-1/2" 5052 Flat End Cap 21-5052-140 <i>Fabricated from Aluminum Sheet</i></p>  <p>Accepts: Hollow Cap #135 - 28-63-215</p>	<p>3" Oval End Cap 21-00-000 Sand Cast</p>  <p>Accepts: Top Cap #147 - 28-63-267</p>	<p>End Cap RW-29 2-5/8 x 1 Dixie End Cap 21-00-235 Sand Cast</p>  <p>Accepts: Hollow Dixie Cap - 28-63-290</p>																																		
<p>End Cap RW-30 2-5/8 x 1-1/2 Dixie Cap 21-00-245 Die Cast</p>  <p>Accepts: Hollow Dixie Cap - 28-63-295</p>	<p>Flat End Cap RW-30 2-5/8 x 1-1/2 Dixie Cap 21-00-245F Sand Cast</p>  <p>Accepts: Hollow Dixie Cap - 28-63-295</p>	<p>3" Round 5052 Flat End Cap 21-5052-120 <i>Fabricated from Aluminum Sheet</i></p>  <p>Accepts: Top Cap #149 - 28-63-265</p>																																				
<p>1-1/4" SCH 40 End Plug 21-00-180 Die Cast</p> 	<p>1-1/2" SCH 40 End Plug 21-00-181 Sand Cast</p> 	<p>SCH 40 Aluminum Pipe End Caps</p> <table border="1"> <thead> <tr> <th>Mill Finish</th> <th>Pipe Size</th> </tr> </thead> <tbody> <tr> <td>APC-100-MF</td> <td>1</td> </tr> <tr> <td>APC-125-MF</td> <td>1-1/4</td> </tr> <tr> <td>APC-150-MF</td> <td>1-1/2</td> </tr> <tr> <td>APC-200-MF</td> <td>2</td> </tr> </tbody> </table> <table border="1"> <thead> <tr> <th>Anodized</th> <th>Pipe Size</th> </tr> </thead> <tbody> <tr> <td>APC-750</td> <td>3/4</td> </tr> <tr> <td>APC-100</td> <td>1</td> </tr> <tr> <td>APC-125</td> <td>1-1/4</td> </tr> <tr> <td>APC-150</td> <td>1-1/2</td> </tr> <tr> <td>APC-200</td> <td>2</td> </tr> </tbody> </table> 	Mill Finish	Pipe Size	APC-100-MF	1	APC-125-MF	1-1/4	APC-150-MF	1-1/2	APC-200-MF	2	Anodized	Pipe Size	APC-750	3/4	APC-100	1	APC-125	1-1/4	APC-150	1-1/2	APC-200	2	<p>SCH 40 Aluminum Pipe Flat End Caps</p> <table border="1"> <thead> <tr> <th>Mill Finish</th> <th>Pipe Size</th> </tr> </thead> <tbody> <tr> <td>FEC-100-MF</td> <td>1"</td> </tr> </tbody> </table> 	Mill Finish	Pipe Size	FEC-100-MF	1"	<p>SCH 40 Black Plastic End Caps</p> <table border="1"> <thead> <tr> <th>Mill Finish</th> <th>Pipe Size</th> </tr> </thead> <tbody> <tr> <td>RN1DBK1</td> <td>3/4"</td> </tr> <tr> <td>RN1-1/4DBK1</td> <td>1"</td> </tr> <tr> <td>RN1625DBK1</td> <td>1-1/4"</td> </tr> </tbody> </table> 	Mill Finish	Pipe Size	RN1DBK1	3/4"	RN1-1/4DBK1	1"	RN1625DBK1	1-1/4"
Mill Finish	Pipe Size																																					
APC-100-MF	1																																					
APC-125-MF	1-1/4																																					
APC-150-MF	1-1/2																																					
APC-200-MF	2																																					
Anodized	Pipe Size																																					
APC-750	3/4																																					
APC-100	1																																					
APC-125	1-1/4																																					
APC-150	1-1/2																																					
APC-200	2																																					
Mill Finish	Pipe Size																																					
FEC-100-MF	1"																																					
Mill Finish	Pipe Size																																					
RN1DBK1	3/4"																																					
RN1-1/4DBK1	1"																																					
RN1625DBK1	1-1/4"																																					

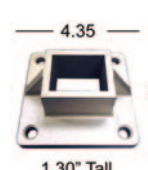
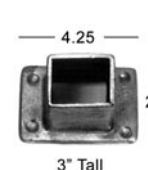
<p>HR1 Wall Mount <u>21-00-187</u> Die Cast</p>  <p>Accepts: Top Cap - HR-1-COLOR</p>	<p>HR3 Wall Mount <u>21-00-316</u> Die Cast</p>  <p>Accepts: Bottom Channel - HR-3-COLOR</p>	<p>HR10 Wall Mount <u>21-00-186</u> Sand Cast</p>  <p>Accepts: Top Cap - HR-10-COLOR</p>	<p>HR12 Wall Mount <u>21-00-185</u> Die Cast</p>  <p>Accepts: Snap Channel HR-12-COLOR</p>	<p>HR12A Wall Mount <u>21-DC-183</u> Die Cast</p>  <p>Accepts: Bottom Channel - HR-12A Bottom Channel - HR-12B Channel - 13-63-300</p>		
<p>HR14 Wall Mount <u>21-DC-155</u> Die Cast</p>  <p>Accepts: Top Cap - HR-14-COLOR</p>	<p>2" x 1" Channel Wall Mount <u>21-00-190</u> Die Cast</p>  <p>Accepts: Channel - 13-63-266 Channel - 13-63-267 Mid Rail Tube - 52-63-11317</p>	<p>2" x 1" Double Ear Channel Wall Mount <u>21-00-191</u> Die Cast</p>  <p>Accepts: Channel - 13-63-266 Channel - 13-63-267 Mid Rail Tube - 52-63-11317</p>	<p>2" x 2" Wall Mount <u>21-00-266</u> Die Cast</p>  <p>Accepts: HR4; 2 x 2</p>	<p>2-1/4" x 4" Wall Mount <u>21-00-190W</u> Sand Cast with Radius</p>  <p>Accepts: Top Cap #140 - 28-63-256</p>		
<p>2-5/8" x 1" Wall Mount <u>21-00-302</u> Die Cast</p>  <p>Accepts: Hollow Cap #129 - 28-63-210 Solid Cap #130 - 28-63-200</p>	<p>2-5/8" x 1-1/2" Wall Mount <u>21-00-160</u> Sand Cast</p>  <p>Accepts: Top Cap #135 - 28-63-215</p>	<p>2-5/8" x 1" Dixie Cap Wall Mount RW-29 <u>21-00-230</u> Sand Cast</p>  <p>Accepts: Hollow Dixie Cap 28-63-290</p>	<p>2-5/8" x 1-1/2" Dixie Cap Wall Mount RW-30 <u>21-00-240</u> Sand Cast</p>  <p>Accepts: Hollow Dixie Cap - 28-63-295</p>	<p>3" Round Cap Wall Mount Special Order <u>21-00-1850</u> Sand Cast</p>  <p>Accepts: Top Cap #149 - 28-63-265</p>		
<p>1-1/2" Square Floor Flange <u>21-00-3090</u> Sand Cast</p>  <p>Accepts: 1.5" Sq Tube; Snap Post HR-16-WH-1</p>	<p>2" Square Floor Flange <u>21-00-210</u> Sand Cast</p>  <p>Accepts: 2" Sq Tube; Snap Post HR-4-COLOR</p>	<p>2" Square Floor Flange <u>21-00-210TM</u> Sand Cast</p>  <p>Accepts: 2" Sq Tube; Snap Post HR-4-COLOR</p>	<p>HR #4A Floor Flange HD <u>21-DC-196</u> Die Cast</p>  <p>Accepts: Snap Post HR-4A-COLOR</p>	<p>HR #4A Floor Flange Special Order <u>21-00-195</u> Sand Cast</p>  <p>Accepts: Snap Post HR-4A-COLOR</p>	<p>1-1/4" SCH 40 <u>21-00-47</u> Sand Cast</p>  <p>Accepts: 1-1/4 SCH 40 Pipe 18-63-230</p>	<p>1-1/4" SCH 40 Floor Flange <u>21-00-48</u> Sand Cast</p>  <p>Accepts: 1-1/4 SCH 40 Pipe 18-63-230</p>

<p>1-1/2" Square Post Cap <u>21-00-174</u> Die Cast</p> 	<p>2" Square Post Cap 21-00-175 Die Cast</p> 	<p>3" Flush Mount Square Post Cap (Inside Insert) <u>21-00-763</u> Sand Cast .125 Wall <i>Used with Universal Enclosure System</i></p> 	<p>3" Square Post Cap 21-00-170 Die Cast</p> 	<p>3" Flat Pyramid Post Cap 21-FT-170 Die Cast</p> 
<p>4" Square Post Cap 51-00-137 Sand Cast</p> 	<p>4" Square Flat Top Pyramid Post Cap <u>51-FT-137</u> Die Cast</p> 	<p>5" Post Cap Casting <u>21-00-255</u> Sand Cast 6" Post Cap Casting <u>21-00-264</u> Sand Cast</p> 	<p>6" Flat Top Post Cap <u>21-FT-264</u> Die Cast</p> 	<p>4" Ball Top for 3" Post <u>21-00-410</u> Sand Cast <i>Round Base for Flag Post Outside Sleeve for 3" OD Post</i></p> 
<p>2-1/4" Ball Top for 3" Post 21-00-097 Sand Cast <i>Outside Sleeve for 3" Post</i></p> 	<p>2-1/4" Ball Top for 4" Post Special Order <u>21-00-355</u> Sand Cast <i>Outside Sleeve for 4" Post</i></p> 	<p>4" Ball Post Cap <u>21-00-600</u> Sand Cast <i>Outside Sleeve for 4" Post</i></p> 	<p>2" Ball Post Cap <u>21-00-139</u> Sand Cast <i>Outside Sleeve for 2" Post</i></p> 	
<p>3/4" Spear <u>21-00-307</u> Die Cast 4.875" exposed height 0.750" insert depth</p>  <p>Accepts: 3/4" x .063 Square Tube</p>	<p>1" Spear <u>21-00-444</u> Die Cast 4.875" exposed height 0.750" insert depth</p>  <p>Accepts: 1" x .063 Square Tube</p>	<p>3/4" Spear (Round Top) <u>21-00-306</u> Die Cast 4.125" exposed height 0.680" insert depth</p>  <p>Accepts: 3/4" x .063 Square Tube</p>	<p>1" Spear (Round Top) <u>21-00-325</u> Die Cast 4.50" exposed height 1.00" insert depth</p>  <p>Accepts: 1" x .063 Square Tube</p>	

Decorative Aluminum Rings Castings

Die Cast
21-00-374 3-1/2" (2-3/4" ID)
21-00-377 3-3/4" (2-3/4" ID)
21-00-415 5" (3-7/8" ID)

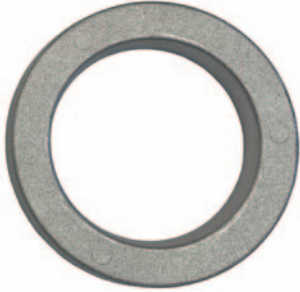

**4" Decorative Aluminum Ring
0.5" x .062" Formed from Extruded
Square Tube**

21-00-380 (3.75 OD)
21-00-375 (3.90 OD; 3" ID)



1" Deco Knot

21-00-1400 Die Cast



**Bullet Rail End Cap
21-00-715**



**Hard-Rok
61-00-007**

Contains no gypsum or chlorides; Quick setting
anchoring Cement;
5 Gallon Bucket



**Quik Rok
61-00-001**

Anchoring Cement;
**NEVER to be used to anchor balcony railing
or any similar human life safety structures**
5 Gallon Bucket



**Mark 5 Gate Hinge
52-63-8793 (Heavy Duty)
with base plate**



**Mark 4 Gate Hinge
52-63-9150 (Heavy Duty)
without base plate**



**Gate Hinge Bearing
GATE-BEARING 1 piece
For use with Mark 4 and Mark 5 Gate Hinges**

